

PFLOW5001 User Manual VA.04

MEMS Mass flow sensors for manifold installation

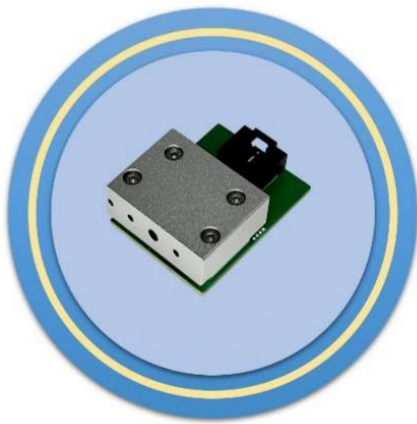

 **Attention !**

- Please carefully read this manual prior to operating this product.
- Do not open or modify any hardware which may lead to irrecoverable damage.
- Do not use this product if you suspect any malfunctions or deflection.
- Do not use this product for corrosive media or in a strong vibration environment.
- Use this product according to the specified parameters.
- Only the trained or qualified personnel shall be allowed to perform product services.

 **Use with caution !**

- Be cautious for electrical safety, and even it operates at a low voltage, any electrical shock might lead to some unexpected damages.
- The gas to be measured should be clean and free of particles, as even light particles may be accumulated inside the tiny pressure port that may result in inaccuracy in metrology, clogging, or other irrecoverable damage.
- Do not apply for any unknown or non-specified gases that may damage the product.

Table of Contents

1. Overview	5
2. Receipt / unpack of the products	6
3. Knowing the products.....	7
3.1 Product description	7
3.2 Power and data pinout description.....	7
3.3 Mechanical dimensions	8
4. Installation	9
5. Basic operation	10
5.1 RS232 communication protocol	10
5.1.1 Serial port settings	10
5.1.2 Command format.....	10
5.1.3 Response format.....	10
5.1.4 Command to read/write variables.....	11
5.1.5 Read flow rate	11
5.1.6 Read serial number	12
5.1.7 Select input mode.....	12
5.1.8 Setpoint	13
5.1.9 Exhaust value	14
5.1.10 Offset calibration	14
5.1.11 P Gain and D Gain	14
5.1.12 Firmware version	15
5.1.13 Filter depth	15
5.2 RS485 Modbus communication protocol	16
5.2.1 Hardware connection	16
5.2.2 Communication parameters	16
5.2.3 Frame	17
5.2.4 Function codes	17
5.2.5 Registers	17
6. Product selection.....	20
7. Product performance	21
7.1 Technical specifications.....	21

7.2	Typical (analog) output	22
7.3	Pressure loss	22
8.	Technical notes for the product performance	23
8.1	Measurement principles	23
8.2	Precautions for the best performance of the product	23
8.2.1	Contamination and sterilization	23
8.2.2	Altitude changes	23
8.2.3	Excessive humidity or condensation	24
8.2.4	Metrology verification	24
9.	Warranty and Liability	25

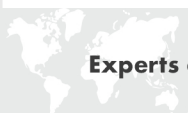

1. Overview

This manual provides essential information for the operation of the PFLOW5001 series of gas mass flow sensors for general-purpose gas flow monitor and control applications with the full-scale mass flow rate from 0.2 to 20 SLPM, and both analog and digital outputs. The product performance, maintenance, and troubleshooting as well as the information for product order, technical support, and repair are also included.

PFLOW5001 product provides the manifold configuration for the mechanical connections. Optionally it can also be offered with a manifold body with the 4mm one-touch flexible piping. It can be applied to medical equipment and instrumentation applications. The series covers a wide dynamic flow range with a working pressure rating of up to 1.0 MPa (10 bar or 150 PSI), and a compensated temperature ranging from -5 to 50°C.

The sensing elements are manufactured with MEMS (micro-electro-mechanical systems) thermal mass flow sensing technologies that measures the calorimetry and diffusivity of the flow medium. The sensor surface is passivated with silicon nitride ceramic materials together with water/oilproof nano-coating for performance and reliability. Compared to the conventional calorimetric flow sensing technology, this unique sensing approach offers better linearity, removes gas sensitivity for gases with similar thermal diffusivities, and improves temperature performance. It can also auto-recognize pre-programmed gases with significant differences in thermal diffusivity. It is the first of a kind in the industry that senses the mass flow with multiple gases without a manual gas conversion factor. As such, it ensures high precision for gas measurements with air calibration.



2. Receipt / unpack of the products

Upon receipt of the products, please check the packing box before dismantling the packing materials. Ensure no damages during shipping. If any abnormality is observed, please contact and notify the carrier who shipped the product and inform the distributors or sales representatives if the order is not placed directly with the manufacturer; otherwise, the manufacturer should be informed. For any further actions, please refer to the return and repair section in this manual.

If the packing box is intact, proceed to open the packing box, and you shall find the product (either the sensor formality per the actual order), together with the power and data cable if the order is included as shown below.

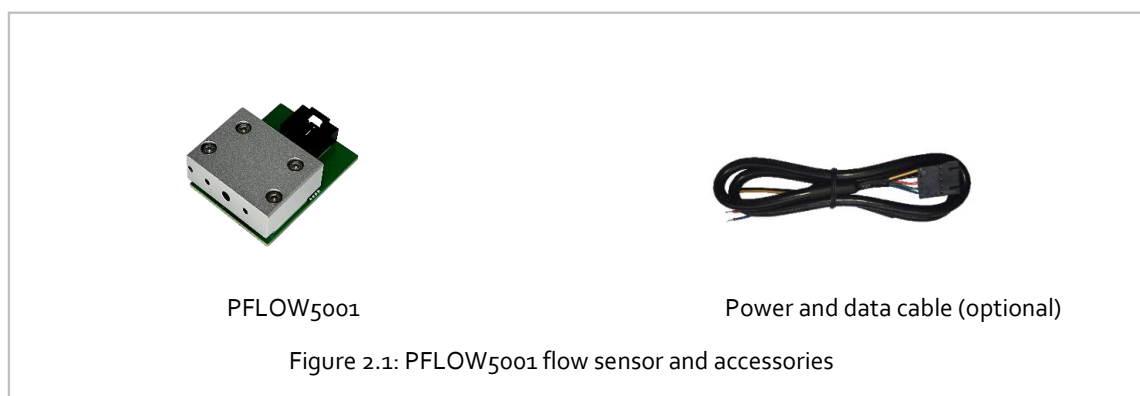

Please check immediately for the integrity of the product and the power and data cable; if any abnormality is identified, please notify the distributor/sales representative or manufacturer as soon as you can. If any defects are confirmed, an exchange shall be arranged immediately via the original sales channel. This user manual shall also be included in the packing box or via an online link for an electronic version which should be sent by your sales agent. In most cases, this manual shall be made available to the customer before the actual order.

3. Knowing the products

3.1 Product description

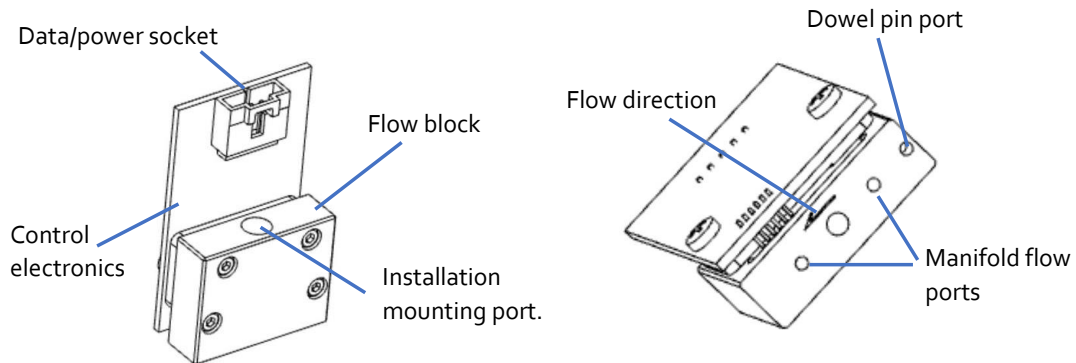

Note: The manifold base port size should not be smaller than those of the flow ports on the product.

Figure 3.1: PFLOW5001 parts description

3.2 Power and data pinout description

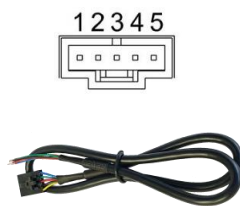

Figure 3.2: PFLOW5001 pinout
2.54mm centers; 0.635mm square

Table 3.1: PFLOW5001 pin/wire assignments.

Wire	Color	Definition
1	Blue	RS485 B(+) / SDA(I ² C)
2	Green	Analog output, 0 ~ 5 Vdc
3	Red	Power supply, 8 ~ 24 Vdc
4	Black	Ground
5	Yellow	RS485 A(-) / SCL(I ² C)



DO NOT connect or disconnect the sensor cable when the power is on!! It will damage the electronic chipsets inside the sensor module! The standard cable has an AMPMODU MTE (5 positions) compatible connector with a length of 0.5 meters.

- Note:**
1. Power supply: The PFLOW5001 requires a power supply of 8 ~ 24 Vdc. No particular requirements for the external power supply, but standard industrial power cautions should be applied.
 2. The analog outputs 0 ~ 5 Vdc are corresponding to the specified full-scale flow range at the time of order. If the analog option is not selected, this pin output could be NULL.

3.3 Mechanical dimensions

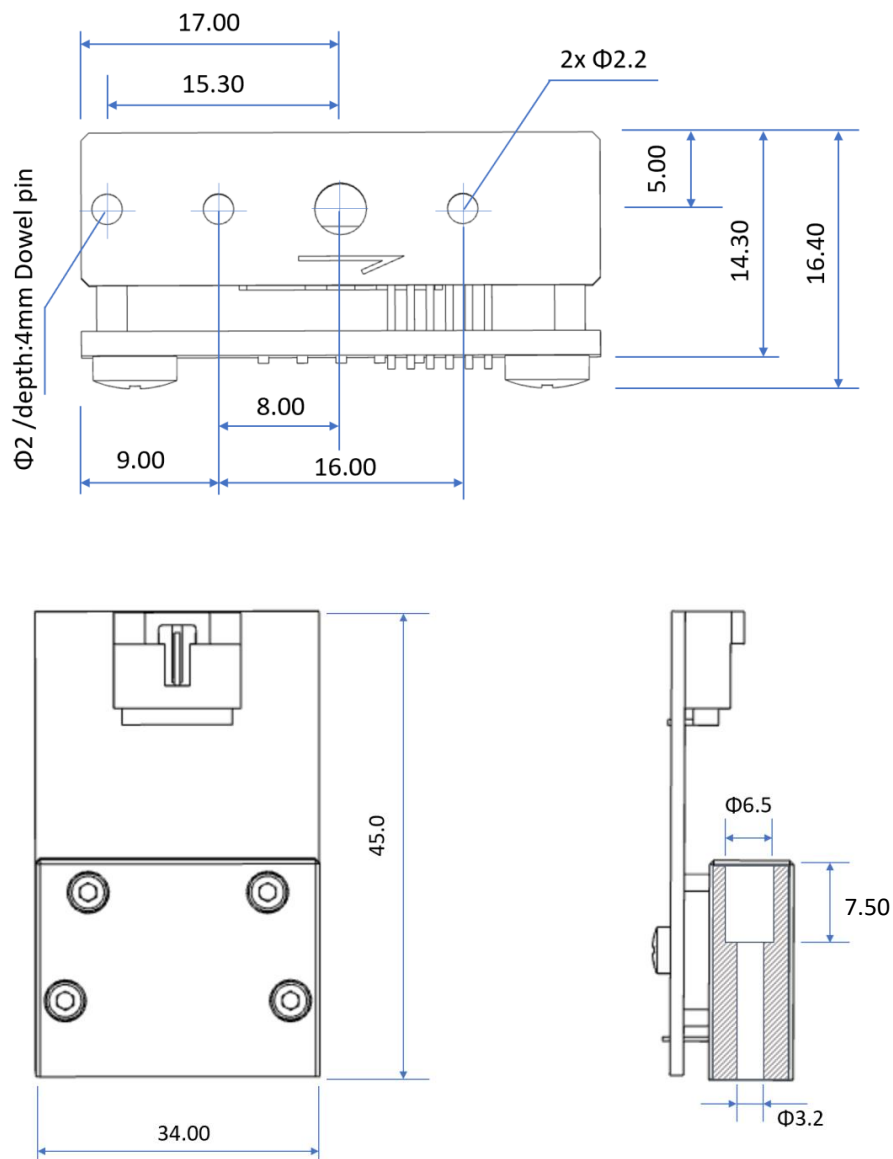

Figure 3.3.1. PFLOW5001 manifold mechanical dimensions.

4. Installation

Do not open or alter any part of the product, which would lead to malfunction and irrecoverable damage.

For the installation, make sure the leakage proof of the connections and all electrical precautions are applied. Please make sure the electrical cable is properly engaged. It should be noted that the sensor is designed for medium to low pressure per the applications, therefore, the system design would be important for flow stability and related flow noises.

In order to prevent over-forced installation, The mounding torque applied should be within 0.35 ± 0.03 N·m. Sealing O-ring is recommended to be the ones that comply with ISO 3601/1; the mounting screw is specified for M3x20mm by ISO 14583; the dowel pin should be $\Phi 2m6 \times 6$ mm.

Please align the products with your gas manifold block properly, and no excessive force should be applied during installation, and subsequent leakage tests would be required for safety and performance.

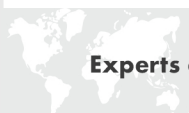

5. Basic operation

5.1 RS232 communication protocol

5.1.1 Serial port settings

	RTU
Baud rate (Bits per second)	57600 bps
Data bits	8
Stop bits	1
Parity	Odd
Flow control	No handshake
Level	TTL / EIA 232

Note: The maximum data writing rate is 100 Bytes/sec. Do not write when the device is active.

5.1.2 Command format

A one-character code is required at the beginning of any request. If the request is more than one byte, a checksum that sums all the preceding bytes values, truncated to the last 8 bits of the results, must be added at the end of the request.



5.1.3 Response format

The response must repeat the requested code, followed by data, ending with a checksum. The STOP request has no response.

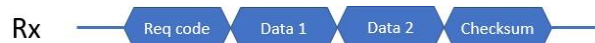

5.1.4 Command to read/write variables

Please note: Channels 1 and 2 are reserved and not available. All read/write variables coded with 1 byte are MSB first. Continuous writing to persistent variables is not recommended, as it may impact the memory's lifetime.

Hex	Command	Parameter	Access	Note
0x61	Read_VAR_INT16	Variable ID		
0x62	Write_VAR_INT16	Variable ID+ Value of 2 bytes (higher first)		
0x63	Read_VAR_CHAR	Variable ID		
0x64	Write_VAR_CHAR	Variable ID+ Value of 1 byte (higher first)		

5.1.5 Read flow rate

Hex	Command	Parameter	Access	Note
0x31	Send_ONE_DATA	None	R/W	Single request, 1 flow value
0x32	Send_N_DATA	Nx 1byte	R/W	N flow value
0x33	Send_CONTINUOUS	None, terminate with stop		Flow values (each 3.5 msec)
0x34	STOP	None	R/W	No response

The digital flow measure range (forward only) is (0...10000) = (0x0000...0x2710) = (0...100 %) F.S.

The maximum reading value is 11000 = 0x2AF8 = 110 % F.S.

$$\text{Real_flow} = \text{digital_flow} / 10000 * \text{max_flow}$$

Example:

Data direction	Hex data	Flow	Remark
Rx	31 32 02 34 33 34	Depends on the flow	Select desired input for set point, 0Hex = digital input, 1Hex= analog input
Tx	31 XX XX YY 32 HH LL YY 32 HH LL YY 33 XX XX YY None	Depends on the flow	YY = Checksum. Translate the Hex value in the Dec value and apply the decoding formula to get the actual flow measure 0x33 returns measured flow continuously each 3.5 ms STOP the continuous reading

5.1.6 Read serial number

Hex	Command	Parameter	Access	Note
0x68	Read_Serial_Number	None	R	Serial number

5.1.7 Select input mode

Hex	Command	Data type	Access	Note
0x1F	Select input mode	UINT8	R/W	Select input mode for set point, 0 = digital input, 1= analog input

Example 1: Check the input mode

Data direction	Hex data	Flow	Remark
Rx	63 1F 82	-	request – variable ID – checksum
Tx	63	-	The device sends back the request

Example 2: Change the input mode

Data direction	Hex data	Flow	Remark
Rx	64 1F 00 83 64 1F 01 84	Last value independent of the previous mode Set point according to analog value present at the input pin	Set the digital input mode Set the analog input mode
Tx	64 64	The device sends back the request	Tx

5.1.8 Setpoint

Hex	Command	Parameter	Access	Note
0x14	CtrlNominal	None	R/W	Set point mass flow

The digital set point range is (0...65535) = (0x0000...0xFFFF) = (0%...100%) F.S.

Example:

Data direction	Hex data	Flow	Remark
Rx	62 14 00 00 76 62 14 02 90 08 62 14 80 00 F6 62 14 FF FF 74	0 % F.S. 1 % F.S. 50 % F.S. 100 % F.S.	Zero flow Cut off limit value if present (on request) Flow set at 50 % of the F.S. Flow set at 100 % of the F.S.
Tx	62	The device sends back the request	The device sends back the request

Example with a 250 sccm F.S. device and a set point of 110 sccm:

$$\text{set point} = 110 \text{ [sccm]} / 250 \text{ [sccm]} * 65535 = 28835 = 0x70A3$$

5.1.9 Exhaust value

Hex	Command	Data type	Access	Note
0x1E	Exhaust value	UINT16	R/W	Exhaust value for open-loop control

Exhaust value is type uint16, the two bytes full range are (0...65535)= (0x0000...0xFFFF)

A value range between (0...4,095) allows direct control of the valve position from 0 corresponding to a closed valve to 4,095 corresponding to a fully open valve. Any value in between corresponds to a valve position, the resulting flow will be a nonlinear function of this value and a consistent offset is necessary to obtain a flow.

Setting the value to 32,768 (0x8000) enables PID control using either a digital or analog setpoint according to the selected mode.

Other values are not used.

5.1.10 Offset calibration

Hex	Command	Data type	Access	Note
0x03	Offset_zero	UINT8	R/W	Read: 0 – completed; 3 – error. Write 0 – none; 2 – reset.

5.1.11 P Gain and D Gain

Hex	Command	Data type	Access	Note
0x17	P Gain	UINT16	R/W	Available value: 0 ~ 9999. The default value is 15.
0x19	D Gain	UINT16	R/W	Available value: 0 ~ 9999. The default value is 25.

5.1.12 Firmware version

Hex	Command	Data type	Access	Note
0x01	Firmware version	UINT16	R	2 bytes (e.g. 3012 = 30.12)

5.1.13 Filter depth

Hex	Command	Parameter	Access	Note
0x07	Filter depth	UINT8	R/W	0 ~ 9, corresponding to 2^0 ~ 2^9 data in the software filter. The default value is 3, corresponding to $2^3 = 8$ data in the software filter

5.2 RS485 Modbus communication protocol

The digital communication protocol is based on standard Modbus RTU Half-plex mode. A master (PC or PLC) can communicate with multiple slaves (the current product) for data exchange and communication parameter configuration. Refer to Table 3.2 for the cable connection.

5.2.1 Hardware connection

The RS485 hardware layer is TIA/EIA-485-A, as illustrated below. In this configuration, the product is a slave.

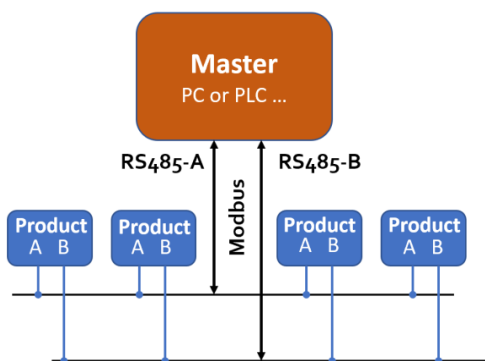

Figure 5.1: RS485 hardware

5.2.2 Communication parameters

The PC UART communication parameters are listed in table 5.1.

Table 5.1: PC UART communication parameters

Parameters	Protocol
	RTU
Baud rate (Bits per second)	38400 bps
Start bits	1
Data bits	8
Stop bits	1
Even/Odd parity	None
Bits period	104.2 μ sec
Bytes period	1.1458 msec
Maximum data length	20
Maximum nodes	247

5.2.3 Frame

The frame function is based on the standard Modbus RTU framing:

Table 5.2: frame function

Start_bits	Address	Function codes	Data	CRC	Stop_bits
T ₁ -T ₂ -T ₃ -T ₄	8 bit	8 bit	N 8 bit (20≥n≥0)	16 bit	T ₁ -T ₂ -T ₃ -T ₄

Start_bits:	4 periods of a bit time for a new frame.
Address:	The address can be set from 1 to 247 except for 157 (0x9d). 0 is the broadcast address.
Function codes:	Define the product's functions/actions (slaves), either execution or response.
Data:	The address of the register, length of data, and the data themselves.
CRC:	CRC verification code. The low byte is followed by the high byte. For example, a 16-bit CRC is divided into BYTE_H and BYTE_L. The BYTE_L will come first in the framing, followed by the BYTE_H. The last one is the STOP signal.
Stop_bits:	4 periods of a bit time for ending the current frame.

5.2.4 Function codes

The Modbus function codes applied for the product are the sub-class of the standard Modbus function codes. These codes are used to set or read the registers of the product:

Table 5.3: function codes

Code	Name	Functions
0x03	Read register	Read register(s)
0x06	Set single register	Write one single 16-bit register
0x10	Set multiple registers	Write multiple registers

5.2.5 Registers

The product has multiple registers available for the assignment of the various functions. With these functions, the user can obtain the data from the products, such as *product address* and *flow rates* from the registers, or set the product functions by writing the corresponding parameters.

The currently available registers are listed in the following table, and the registers may be customized upon contacting the manufacturer. Where R: read; W: write-only; W/R: read and write.

Note: At the time of shipping, the write protection function is enabled except for address and baud rate. Once the user completes the register value change, the write protection will be automatically enabled again to prevent incidental data loss.

Table 5.4: Registers

Functions	Description	Register	Modbus
Address	Product address (R/W)	0x0081	40130 (0x0081)
Serial number	Serial number of the product (R)	0x0030	40049 (0x0030)
Flow rate	Current flow rate (R)	0x003A ~ 0x003B	40059 (0x003A)
Baud rate	Communication baud rate (R/W)	0x0082	40131 (0x0082)
GCF	Gas conversion factor (R/W)	0x008B	40140 (0x008B)
Digital filter depth	Response time or sampling time (R/W)	0x008C	40141 (0x008C)
Offset calibration	Offset reset or calibration (W)	0x00Fo	40241 (0x00Fo)
Write protection	Write protection of selected parameters (W)	0x00FF	40256 (0x00FF)

The detailed information of each register is described below: Y: enabled; N: disabled

Address	0x0081	Write	Y
		Read	Y
Description	Address of the product		
Value type	UINT 16		
Notes	Values from 1 to 247 except for 157 (0x9d). The broadcast address is not enabled, and the default address is 1.		

SN, Serial number	0x0030	Write	N
		Read	Y
Description	Series Number of the product, SN		
Value type	UINT 8 (12 bits)		
Notes	SN= value(0x0030), value(0x0031),...,value (0x0035); Receiving 12 bits as 2A 41 31 42 32 33 34 35 36 2A, the corresponding Serial Number is **A1B23456**.		

Flow rate	0x003A ~ 0x003B	Write	N
		Read	Y
Description	Current flow rate		
Value type	UINT 16		
Notes	Flow rate = [Value (0x003A) * 65536 + value (0x003B)] / 1000 e.g., When the user reads "0" from register 0x003A and "20340" from register 0x003B, the current flow rate = (0 * 65536 + 20340) / 1000 = 20.340 SLPM		

Baud rate	0x0082	Write	Y
		Read	Y
Description	Communication baud rate		
Value type	UINT 16		

Notes	0: baud rate=4800; 1: baud rate=9600; 2: baud rate=19200; 3 baud rate=38400. The default value is 3. e.g., When the user reads "3" from register 0x0082, the baud rate is 38400.		
GCF	0x008B	Write	Y
		Read	Y
Description	The gas conversion factor for applicable gas is different from the calibration gas		
Value type	UINT 16		
Notes	The GCF of air is 1000 (default), typically read from register 0x008B. Note: The product will disable this function with write protection once the metering gas is confirmed with the proper GCF. For a specific GCF value, please contact the manufacturer.		

Response time	0x008C	Write	Y
		Read	Y
Description	Digital filter depth setting		
Value type	UINT 16		
Notes	0 ~ 9 programmable, corresponding to 2 ⁰ ~ 2 ⁹ data sampling in the software filter. The default value is 3, corresponding to 2 ³ = 8 data sampling.		

Offset calibration	0x00Fo	Write	Y
		Read	N
Description	Reset or calibrate the offset		
Value type	UINT 16, Fixed value 0xAA55		
Notes	To reset or calibrate the offset, write 0xAA55 to register 0x00Fo. Note: When executing this function, ensure there is NO flow in the flow channel.		

Write protection	0x00FF	Write	Y
		Read	N
Description	Write protection disabler for a set value to a specific register.		
Value type	UINT 16, Fixed value 0xAA55		
Notes	This function is enabled at the time of product shipment. To enable the write function of a specific parameter, such as GCF or offset, the user needs to send 0xAA55 to the register 0x00FF, and then the write function will be enabled (write protection is disabled). After the write execution is completed, the firmware will automatically re-enable the write protection.		

6. Product selection

The product part number is composed of the product model number and suffixes, indicating each of the selectable parameters. Refer to the following for details.

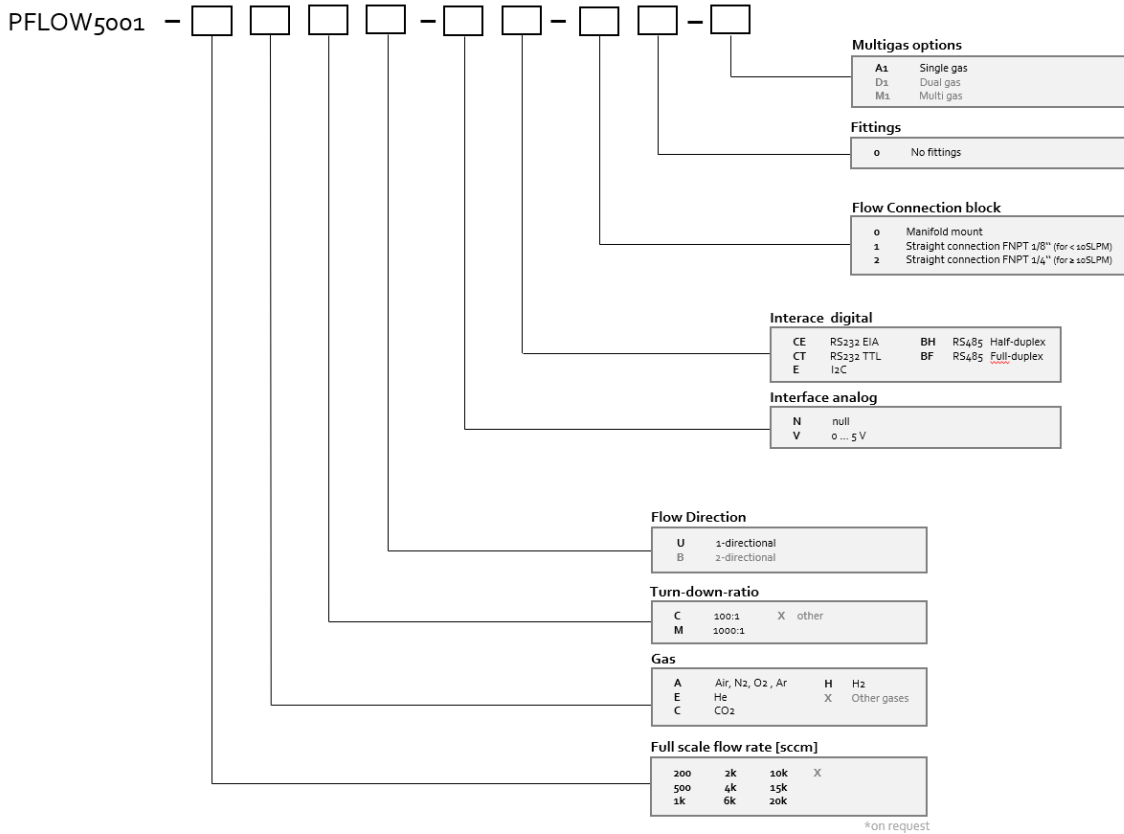

Example:
PFLOW5001-200ACU-NCE-00-A1
 (Max = 26 Characters)

Note: For CO₂, the full-scale flow is 60% of the specified ones.

7. Product performance

7.1 Technical specifications

All specifications listed in the following table, unless otherwise noted, apply for calibration conditions at 20°C and 101.325 kPa absolute pressure with air.

	Value	Unit
Flow range	0 ~ 100...20000; or 0~±100 ...±20000	sccm
Accuracy	±(1.5+0.5FS)	%
Repeatability	0.5	%
Turn-down ratio	100:1	
Response time*	10	msec
Temperature range	-5 ~ 50	°C
Maximum pressure	1.0 (150)	MPa (psi)
Humidity	<95, no condensation	%RH
Analog null shift	±30	mV
Power supply	8 ~ 24	Vdc
Working current	50	mA
Output	Linear, analog 0 ~ 5 Vdc / Rs485 Modbus / I ² C	
Analog load	Sourcing: 25 / Sinking: 15	mA
Maximum overflow	3000 (3SLPM) (200, 500, 1000 models); 18000 (18 SLPM) (2000, 4000, 6000 models) 45000(45SLPM) (10000, 15000 models)	sccm (SLPM)
Maximum flow change	500 (200, 500, 1000 models); 3000 (2000, 4000, 6000 models) 7500(10000, 15000 models)	sccm/sec
Calibration	Air @ 0°C, 101.325 kPa	
Storage temperature	-20 ~ +70	°C
Compliance	RoHS; REACH	
CE	IEC 61000-4-2; 4-8	
Wetted materials	Aluminum alloy; silicon nitride; Ablestik 84-3J; FR4	

- Note:**
1. Allow the product to warm up for 60 seconds for the best performance.
 2. Response time shown is the default. It can be programmed to the fastest <2 msec.

7.2 Typical (analog) output

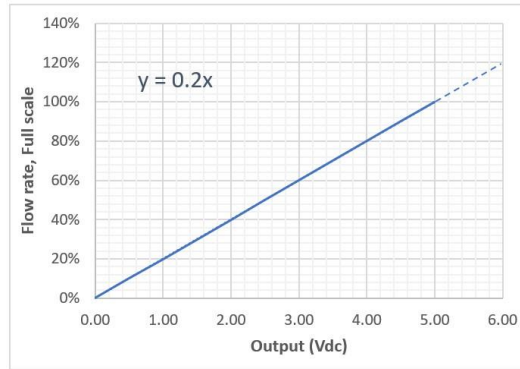

Figure 7.1: Typical analog output

7.3 Pressure loss

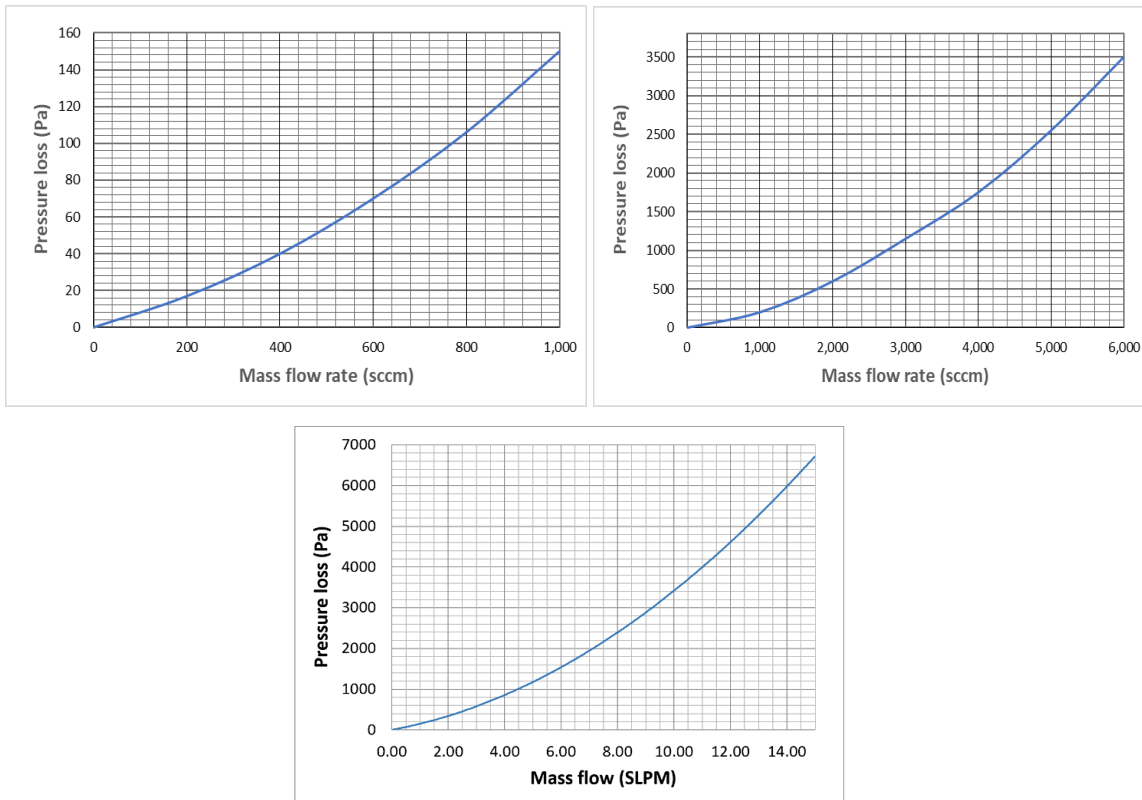

Figure 7.2: Upper row: from left to right, for models of full scale up to 1000 sccm; and of full scale from 2000 to 6000 sccm. Lower row: models of full scale from 10000 to 15000 sccm (10 to 15SLPM).

8. Technical notes for the product performance

8.1 Measurement principles

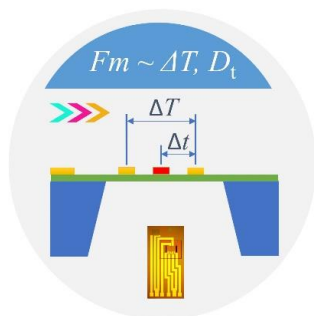

Figure 8.1: Illustration of the measurement principle.

The products utilize micro-machined (MEMS) calorimetric sensing with thermal diffusivity detection and data process technology. A thermal signal generator with a pair of sensing elements up and downstream of the microheater is precisely manufactured and separated at predefined micrometer distances on a chip surface with excellent thermal isolation. When a fluid is flowing through the sensing chip, the fluid carries the thermal signal downstream. The sensing elements register the temperature differences and measure the fluidic thermal diffusivity, further correlated to the fluid mass flow rate via the calibration process.

Compared to the calorimetric sensing products offered by other manufacturers on the market, this sensing approach offers a large dynamic range with a better performance against environmental parameter alternations. It removes some gas sensitivities for gases with the same diffusivity and much-improved the linearity when a gas conversion factor is used for the metering of the non-calibration gases.

Precautions for the best performance of the product

8.1.1 Contamination and sterilization

It is critical to have the measurements performed in a contamination-free environment for data accuracy. Excessive contaminants such as vapors will lead to data deviation or even product malfunctions in severe cases.

For medical applications, it may be desired to have the product to be sterilized from time to time. A standard EtO sterilization process is recommended. For the detailed procedure please consult your local experts or contact the manufacturer.

8.1.2 Altitude changes

Unlike some other products on market, the design of the sensor has a built-in pressure balancer that prevents membrane deformation due to altitude changes. Therefore, the sensor is intrinsically insensitive to altitude change-induced errors. The specified altitude in Sec 7.1 has been fully tested.

8.1.3 Excessive humidity or condensation

The humidity change will not alter the performance of the sensor. However, if excessive humidity is present resulting in condensation, the measurement port or channel could be blocked or altered. This would result in a very unreliable data output. Please filter or other tools to prevent this situation to occur when using this product.

8.1.4 Metrology verification

Testing the products with local metrology tools will be performed in almost all cases. It should be noted that for this particular sensor, special care should be applied while performing such a task.

The gauge pressure tests are relatively simple, as long as the pressure is tested under a stable media condition, the metrology data should be well reproduced.

For the mass flowrate comparison, however, in addition to the flow system setup conditions recommended by OIML R137, a stable flow system must be ensured. This is because the current product is designed for a small pressure loss, therefore the sensor does not have a strong flow restrictor or conditioners to handle the flow instability that may exist in the system. Therefore to compare the metrology data, the user should ensure the system is stable, otherwise, the output could be noisy and metrology deviations would be inevitable. If such cases are present, please contact the manufacturer for further solutions.

For temperature and humidity measurement, because of the small package space, the response of the humidity could be slower than specified. For additional information, please contact the manufacturer.

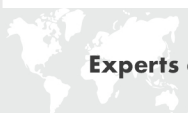

9. Warranty and Liability

(Effective January 2018)

APSP warrants the products sold hereunder, properly used, and properly installed under normal circumstances and service. As described in this user manual, it shall be free from faulty materials or workmanship for 180 days for OEM products and 365 days for non-OEM products from the date of shipment. This warranty period is inclusive of any statutory warranty. Any repair or replacement serviced product shall bear the same terms in this warranty.

APSP makes no warranty, representation, or guarantee and shall not assume any liability regarding the suitability of the products described in this manual for any purposes that are not specified in this manual. The users shall be held full responsibility for validating the performance and suitability of the products for their particular design and applications. For any misuse of the products out of the scope described herein, the user shall indemnify and hold APSP and its officers, employees, subsidiaries, affiliates, and sales channels harmless against all claims, costs, damages, and expenses or reasonable attorney fees from direct or indirect sources.

APSP makes no other warranty, express or implied, and assumes no liability for any special or incidental damage or charges, including but not limited to any damages or charges due to installation, dismantling, reinstallation, etc. other consequential or indirect damages of any kind. To the extent permitted by law, the exclusive remedy of the user or purchaser, and the limit of APSP's liability for any and all losses, injuries, or damages concerning the products, including claims based on contract, negligence, tort, strict liability, or otherwise shall be the return of products to APSP, and upon verification of APSP to prove to be defective, at its sole option, to refund, repair or replacement of the products. Regardless of form, no action may be brought against APSP more than 365 days after a cause of action has accrued. The products returned under warranty to APSP shall be at the user or purchaser's risk of loss and will be returned, if at all, at APSP's risk of loss. Purchasers or users are deemed to have accepted this limitation of warranty and liability, which contains the complete and exclusive limited warranty of APSP. It shall not be amended, modified, or its terms waived except by APSP's sole action.

This manual's product information is believed to be accurate and reliable at the time of release or made available to the users. However, APSP shall assume no responsibility for any inaccuracies and/or errors and reserves the right to make changes without further notice for the relevant information herein.

This warranty is subject to the following exclusions:

- (1) Products that have been altered, modified, or have been subject to unusual physical or electrical circumstances indicated but not limited to those stated in this document or any other actions which cannot be deemed as proper use of the products;

- (2) Products that have been subject to chemical attacks, including exposure to corrosive substances or contaminants. In the case of battery usage, long-term discharge, or leakage-induced damages;
- (3) Products that have been opened or dismantled for whatever reasons;
- (4) Products that have been subject to working conditions beyond the technical specification as described by this manual or related datasheet published by the manufacturer;
- (5) Any damages incurred by the incorrect usage of the products;
- (6) APSP does not provide any warranty on finished goods manufactured by others. Only the original manufacturer's warranty applies;
- (7) Products that are re-sold by unauthorized dealers or any third parties.

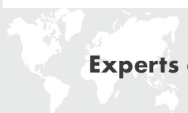

We are here for you. Addresses and Contacts.

Headquarter Switzerland:

Angst+Pfister Sensors and Power AG
Thurgauerstrasse 66
CH-8050 Zurich
Phone +41 44 877 35 00
sensorsandpower@angst-pfister.com

Office Germany:

Angst+Pfister Sensors and Power Deutschland GmbH
Edisonstraße 16
D-85716 Unterschleißheim
Phone +49 89 374 288 87 00
sensorsandpower.de@angst-pfister.com

Scan here and get an overview of personal contacts!



sensorsandpower.angst-pfister.com
