

High Speed Single-Channel Digital Isolators

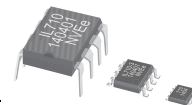

Functional Diagram

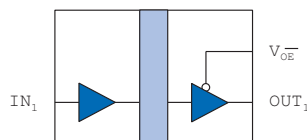

IL710

Truth Table

V_I	V_{OE}	V_O
L	L	L
H	L	H
L	H	Z
H	H	Z

Features

- High Speed: 150 Mbps typical (IL710S)
- 2500 V_{RMS} isolation voltage
- 100 $kV/\mu s$ common mode transient immunity
- No carrier or clock for low EMI emissions and susceptibility
- 2.7 to 5.5 volt supply range
- 1.2 mA/channel typical quiescent current
- 300 ps typical pulse width distortion (IL710S)
- 100 ps pulse jitter
- 2 ns channel-to-channel skew
- 10 ns typical propagation delay
- 44000 year barrier life
- Excellent magnetic immunity
- VDE V 0884 certified; UL 1577 recognized
- 500 V_{RMS} IS-to-IS intrinsically safe
- 8-pin MSOP, SOIC, and PDIP packages

Applications

- Digital Fieldbus
- RS-485 and RS-422
- Ground loop elimination
- Peripheral interfaces
- Serial communication
- Logic level shifting
- Equipment covered under IEC 61010-1 Edition 3
- 5 kV_{RMS} rated IEC 60601-1 medical applications

Description

NVE's IL700 family of high-speed digital isolators are CMOS devices manufactured with NVE's patented* IsoLoop[®] spintronic Giant Magnetoresistive (GMR) technology.

A unique ceramic/polymer composite barrier provides excellent isolation and virtually unlimited barrier life.

The symmetric magnetic coupling barrier provides a typical propagation delay of only 10 ns and a pulse width distortion as low as 300 ps (0.3 ns), achieving the best specifications of any isolator. Minimum transient immunity of 100 $kV/\mu s$ is unsurpassed. The IL710 is ideal for isolating applications such as PROFIBUS, RS-485, and RS-422.

The IL710 is available in 8-pin MSOP, SOIC, and PDIP packages.

The IL710S is the world's fastest isolator of its type, with a 150 Mbps typical data rate. Standard and S-Grade parts are specified over a temperature range of $-40^{\circ}C$ to $+100^{\circ}C$. T-Grade parts are specified over a temperature range of $-40^{\circ}C$ to $+125^{\circ}C$. The MSOP V-Series version offers full 2500 V_{RMS} isolation in an ultraminiature package.

IsoLoop is a registered trademark of NVE Corporation.
*U.S. Patent numbers 5,831,426; 6,300,617 and others.

REV. AH

Absolute Maximum Ratings

Parameters	Symbol	Min.	Typ.	Max.	Units	Test Conditions
Storage Temperature	T_S	-55		150	°C	
Junction Temperature	T_J	-55		150	°C	
Ambient Operating Temperature ⁽¹⁾ IL710T	T_A	-40		100 125	°C	
Supply Voltage	V_{DD1}, V_{DD2}	-0.5		7	V	
Input Voltage	V_I	-0.5		$V_{DD1}+0.5$	V	
Input Voltage	V_{OE}^-	-0.5		$V_{DD2}+0.5$	V	
Output Voltage	V_O	-0.5		$V_{DD2}+0.5$	V	
Output Current Drive	I_O			10	mA	
Lead Solder Temperature				260	°C	10 sec.
ESD			2		kV	HBM

Recommended Operating Conditions

Parameters	Symbol	Min.	Typ.	Max.	Units	Test Conditions
Ambient Operating Temperature IL710 and IL710S	T_A	-40		100	°C	
IL710T		-40		125	°C	
Junction Temperature IL710 and IL710S	T_J	-40		110	°C	
IL710T		-40		125	°C	
Supply Voltage	V_{DD1}, V_{DD2}	2.7		5.5	V	
Logic High Input Voltage	V_{IH}	2.4		V_{DD1}	V	
Logic Low Input Voltage	V_{IL}	0		0.8	V	
Input Signal Rise and Fall Times	t_{IR}, t_{IF}			1	µs	

Safety and Approvals

VDE V 0884-10 (VDE V 0884-11 pending)

Basic Isolation; VDE File Number 5016933-4880-0001

- Isolation voltage (V_{ISO}): 2500 V_{RMS}
- Transient overvoltage (V_{IOTM}): 4000 V_{PK}
- Surge rating: 4000 V_{PK}
- Each part tested at 1590 V_{PK} for 1 second, 5 pC partial discharge limit.
- Samples tested at 4000 V_{PK} for 60 sec.; then 1358 V_{PK} for 10 sec. with 5 pC partial discharge limit.
- Working Voltage (V_{IORM} ; pollution degree 2):

Package	Part No. Suffix	Working Voltage
MSOP8	-1	399 V_{RMS}
PDIP8	-2	1000 V_{RMS}
SOIC8	-3	1000 V_{RMS}

Safety-Limiting Values	Symbol	Value	Units
Safety rating ambient temperature	T_S	180	$^{\circ}C$
Safety rating power (180 $^{\circ}C$)	P_S	270	mW
Supply current safety rating (total of supplies)	I_S	54	mA

UL 1577 (Component Recognition Program File Number E207481)

- 2500 V rating for all types other than MSOP.
- Each part other than MSOP tested at 3000 V_{RMS} (4240 V_{PK}) for 1 second; each lot sample tested at 2500 V_{RMS} (3530 V_{PK}) for 1 minute.
- MSOP rating 1000 V; tested at 1200 V_{RMS} (1768 V_{PK}) for 1 second; each lot sample tested at 1500 V_{RMS} (2121 V_{PK}) for 1 minute.

ATEC / IEC 60079-0 / 60079-11 (Intrinsic Safety under Explosive Atmosphere Standards)

- IS-to-IS Certification pending
- 500 V_{RMS} rating

Soldering Profile

Per JEDEC J-STD-020C, MSL 1

IL710 Pin Connections

1	V_{DD1}	Supply voltage
2	IN	Data In
3	NC	No internal connection
4	GND_1	Ground return for V_{DD1}
5	GND_2	Ground return for V_{DD2}
6	OUT	Data Out
7	V_{OE}	Output enable. Internally held low with 100 k Ω
8	V_{DD2}	Supply voltage

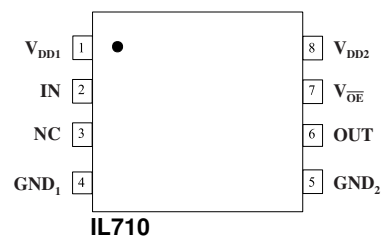

Timing Diagram

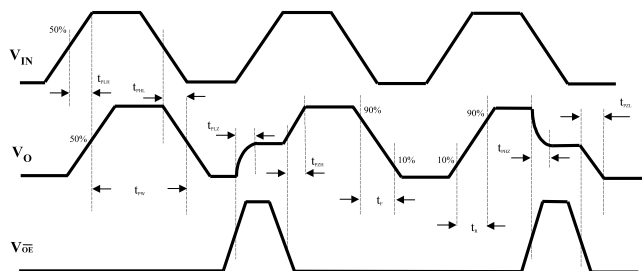

Legend

t_{PLH}	Propagation Delay, Low to High
t_{PHL}	Propagation Delay, High to Low
t_{PW}	Minimum Pulse Width
t_{PLZ}	Propagation Delay, Low to High Impedance
t_{PZH}	Propagation Delay, High Impedance to High
t_{PHZ}	Propagation Delay, High to High Impedance
t_{PZL}	Propagation Delay, High Impedance to Low
t_R	Rise Time
t_F	Fall Time

3.3 Volt Electrical Specifications (T _{min} to T _{max} unless otherwise stated)						
Parameters	Symbol	Min.	Typ.	Max.	Units	Test Conditions
Input Quiescent Supply Current	I _{DD1}		8	10	μA	
Output Quiescent Supply Current	I _{DD2}		1.2	1.75	mA	
Logic Input Current	I _I	-10		10	μA	
Logic High Output Voltage	V _{OH}	V _{DD} -0.1	V _{DD}		V	I _O = -20 μA, V _I = V _{IH}
		0.8 x V _{DD}	0.9 x V _{DD}			I _O = -4 mA, V _I = V _{IH}
Logic Low Output Voltage	V _{OL}		0	0.1	V	I _O = 20 μA, V _I = V _{IL}
			0.5	0.8		I _O = 4 mA, V _I = V _{IL}

Switching Specifications (V _{DD} = 3.3 V)						
Maximum Data Rate IL710, IL710T, and IL710V IL710S		100 130	110 140		Mbps Mbps	C _L = 15 pF C _L = 15 pF
Pulse Width ⁽⁷⁾	PW	10	7.5		ns	50% Points, V _O
Propagation Delay Input to Output (High to Low)	t _{PHL}		12	18	ns	C _L = 15 pF
Propagation Delay Input to Output (Low to High)	t _{PLH}		12	18	ns	C _L = 15 pF
Propagation Delay Enable to Output (High to High Impedance)	t _{PHZ}		3	5	ns	C _L = 15 pF
Propagation Delay Enable to Output (Low to High Impedance)	t _{PLZ}		3	5	ns	C _L = 15 pF
Propagation Delay Enable to Output (High Impedance to High)	t _{PZH}		3	5	ns	C _L = 15 pF
Propagation Delay Enable to Output (High Impedance to Low)	t _{PZL}		3	5	ns	C _L = 15 pF
Pulse Width Distortion ⁽²⁾ IL710, IL710T, and IL710V IL710S	PWD		2 1	3 3	ns	C _L = 15 pF
Pulse Jitter ⁽¹⁰⁾	t _J		100		ps	C _L = 15 pF
Propagation Delay difference between any two parts ⁽³⁾	t _{PSK}		4	6	ns	C _L = 15 pF
Output Rise Time (10%–90%)	t _R		2	4	ns	C _L = 15 pF
Output Fall Time (10%–90%)	t _F		2	4	ns	C _L = 15 pF
Common Mode Transient Immunity (Output Logic High or Logic Low) ⁽⁴⁾	CM _H , CM _L	100	150		kV/μs	Per IEC 60747
Dynamic Power Consumption ⁽⁶⁾						
Output side			140	240	μA/Mbps/ch	
Input side			20	40		

Magnetic Field Immunity ⁽⁸⁾ (V _{DD2} = 3 V, 3 V < V _{DD1} < 5.5 V)						
Power Frequency Magnetic Immunity	H _{PF}		1500		A/m	50Hz/60Hz
Pulse Magnetic Field Immunity	H _{PM}		2000		A/m	t _p = 8μs
Damped Oscillatory Magnetic Field	H _{OSC}		2000		A/m	0.1Hz – 1MHz
Cross-axis Immunity Multiplier ⁽⁹⁾	K _X		2.5			

5 Volt Electrical Specifications (T_{min} to T_{max} unless otherwise stated)						
Parameters	Symbol	Min.	Typ.	Max.	Units	Test Conditions
Input Quiescent Supply Current	I_{DD1}		10	15	μ A	
Output Quiescent Supply Current	I_{DD2}		1.8	2.5	mA	
Logic Input Current	I_I	-10		10	μ A	
Logic High Output Voltage	V_{OH}	$V_{DD}-0.1$	V_{DD}		V	$I_O = -20 \mu\text{A}, V_I = V_{IH}$
		$0.8 \times V_{DD}$	$0.9 \times V_{DD}$			$I_O = -4 \text{ mA}, V_I = V_{IH}$
Logic Low Output Voltage	V_{OL}		0	0.1	V	$I_O = 20 \mu\text{A}, V_I = V_{IL}$
			0.5	0.8		$I_O = 4 \text{ mA}, V_I = V_{IL}$

Switching Specifications ($V_{DD} = 5 \text{ V}$)						
Maximum Data Rate IL710, IL710T, and IL710V IL710S		100 130	110 150		Mbps Mbps	$C_L = 15 \text{ pF}$ $C_L = 15 \text{ pF}$
Pulse Width ⁽⁷⁾	PW	10	7.5		ns	50% Points, V_o
Propagation Delay Input to Output (High to Low)	t_{PHL}		10	15	ns	$C_L = 15 \text{ pF}$
Propagation Delay Input to Output (Low to High)	t_{PLH}		10	15	ns	$C_L = 15 \text{ pF}$
Propagation Delay Enable to Output (High to High Impedance)	t_{PHZ}		3	5	ns	$C_L = 15 \text{ pF}$
Propagation Delay Enable to Output (Low to High Impedance)	t_{PLZ}		3	5	ns	$C_L = 15 \text{ pF}$
Propagation Delay Enable to Output (High Impedance to High)	t_{PZH}		3	5	ns	$C_L = 15 \text{ pF}$
Propagation Delay Enable to Output (High Impedance to Low)	t_{PZL}		3	5	ns	$C_L = 15 \text{ pF}$
Pulse Width Distortion ⁽²⁾ IL710, IL710T, and IL710V IL710S	PWD		2 0.3	3 3	ns	$C_L = 15 \text{ pF}$
Propagation Delay difference between any two parts ⁽³⁾	t_{PSK}		4	6	ns	$C_L = 15 \text{ pF}$
Output Rise Time (10%–90%)	t_R		1	3	ns	$C_L = 15 \text{ pF}$
Output Fall Time (10%–90%)	t_F		1	3	ns	$C_L = 15 \text{ pF}$
Common Mode Transient Immunity (Output Logic High or Logic Low) ⁽⁴⁾	$ CM_H , CM_L $	100	150		kV/ μ s	Per IEC 60747
Dynamic Power Consumption ⁽⁶⁾						
¹⁾ Output side			200	340	μ A/Mbps/ch	
Input side			30	50		

Magnetic Field Immunity ⁽⁸⁾ ($V_{DD2} = 5 \text{ V}, 3 \text{ V} < V_{DD1} < 5.5 \text{ V}$)						
Power Frequency Magnetic Immunity	H_{PF}		3500		A/m	50Hz/60Hz
Pulse Magnetic Field Immunity	H_{PM}		4500		A/m	$t_p = 8 \mu\text{s}$
Damped Oscillatory Magnetic Field	H_{OSC}		4500		A/m	0.1Hz – 1MHz
Cross-axis Immunity Multiplier ⁽⁹⁾	K_X		2.5			

Insulation Specifications

Parameters	Symbol	Min.	Typ.	Max.	Units	Test Conditions
Creepage Distance (external)						
MSOP		3.01			mm	
SOIC		4.04			mm	
PDIP		6.8			mm	
Total Barrier Thickness (internal)						
		0.012	0.013		mm	
Leakage Current ⁽⁵⁾						
			0.2		μA	240 V _{RMS} , 60 Hz
Barrier Resistance ⁽⁵⁾						
	R _{IO}		>10 ¹⁴		Ω	500 V
Barrier Capacitance ⁽⁵⁾						
	C _{IO}		1.1		pF	f = 1 MHz
Comparative Tracking Index						
	CTI	≥175			V	Per IEC 60112
High Voltage Endurance (Maximum Barrier Voltage for Indefinite Life)						
	AC	V _{IO}	1000		V _{RMS}	At maximum operating temperature
	DC		1500		V _{DC}	
Barrier Life						
			44000		Years	100°C, 1000 V _{RMS} , 60% CL activation energy

Thermal Characteristics

Parameter	Symbol	Min.	Typ.	Max.	Units	Test Conditions
Junction–Ambient Thermal Resistance	MSOP		184		°C/W	Double-sided PCB in free air
	SOIC		134			
	PDIP		114			
Junction–Case (Top) Thermal Resistance	MSOP		15		°C/W	
	SOIC		10			
	PDIP		36			
Power Dissipation	P _D			500 675 800	mW	

Notes (apply to both 3.3 V and 5 V specifications):

1. Absolute maximum ambient operating temperature means the device will not be damaged if operated under these conditions. It does not guarantee performance.
2. PWD is defined as $t_{PHL} - t_{PLH}$. %PWD is equal to PWD divided by pulse width.
3. t_{PSK} is the magnitude of the worst-case difference in t_{PHL} and/or t_{PLH} between devices at 25°C.
4. CM_H and CM_L are the maximum common mode voltage slew rates that can be applied with the outputs remaining stable and within V_{OL} and V_{OH} specifications.
5. Device is considered a two terminal device: pins 1–4 shorted and pins 5–8 shorted.
6. Dynamic power consumption is calculated per channel.
7. Minimum pulse width is the minimum value at which specified PWD is guaranteed.
8. The relevant test and measurement methods are given in the Electromagnetic Compatibility section on p. 7.
9. External magnetic field immunity is improved by this factor if the field direction is “end-to-end” rather than to “pin-to-pin” (see diagram on p. 7).
10. 66,535-bit pseudo-random binary signal (PRBS) NRZ bit pattern with no more than five consecutive 1s or 0s; 800 ps transition time.

Typical Performance Graphs

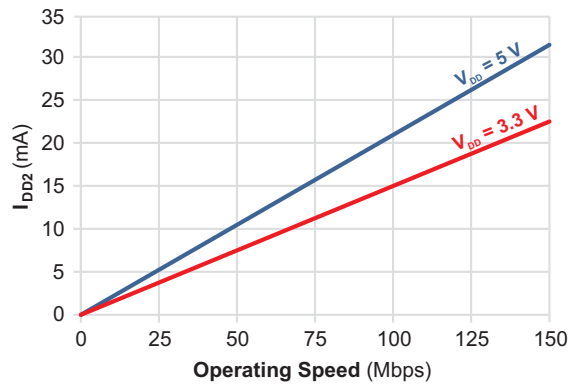

Figure 1. Supply current vs. operating speed.

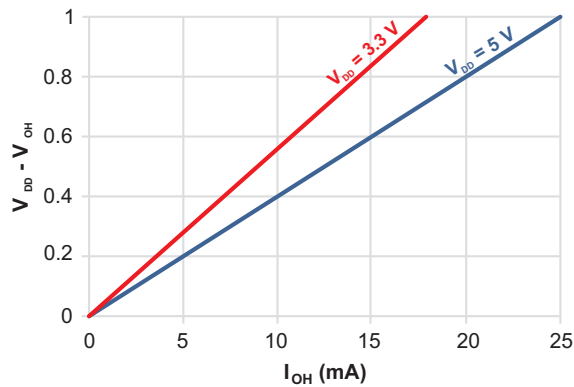

Figure 2. Typical high output voltage vs. load.

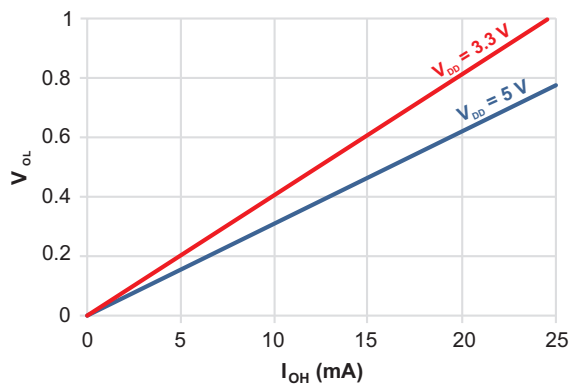
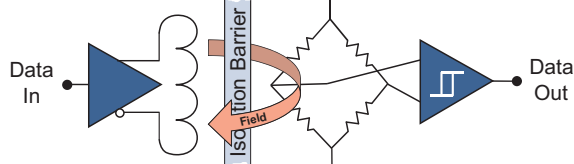

Figure 3. Typical low output voltage vs. load

Application Information

Isolator Operation

An equivalent circuit is shown below:



Isolator Signal Path

The GMR isolator signal path starts with a buffered input signal that is driven through an ultraminiature coil. This generates a small magnetic field that changes the electron spin polarization of GMR resistors, which are configured as a Wheatstone bridge. The change in spin polarization of the resistors creates a bridge voltage which drives an output comparator to construct an isolated version of the input signal.

Small Size, High Speed, and Low EMI

The coil, GMR, and circuitry are integrated to allow small packages. GMR is inherently high speed and low distortion, and unlike transformers, does not rely on energy transfer, so power is low and EMI emissions are minimal.

High Magnetic Immunity

GMR provides large signals which improve magnetic immunity, and the Wheatstone bridge configuration cancels ambient common-mode magnetic fields, further enhancing immunity to external magnetic fields.

Electrostatic Discharge Sensitivity

This product has been tested for electrostatic sensitivity to the limits stated in the specifications. However, NVE recommends that all integrated circuits be handled with appropriate care to avoid damage. Damage caused by inappropriate handling or storage could range from performance degradation to complete failure.

Electromagnetic Compatibility

IsoLoop Isolators have the lowest EMC footprint of any isolation technology. IsoLoop Isolators' Wheatstone bridge configuration and differential magnetic field signaling ensure excellent EMC performance against all relevant standards. These isolators are fully compliant with IEC 61000-6-1 and IEC 61000-6-2 standards for immunity, and IEC 61000-6-3, IEC 61000-6-4, CISPR, and FCC Class A standards for emissions.

Immunity to external magnetic fields is even higher if the field direction is "end-to-end" rather than to "pin-to-pin" as shown in the diagram below:

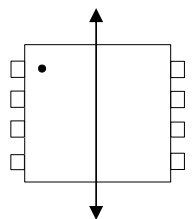

Cross-axis Field Direction

Dynamic Power Consumption

IsoLoop Isolators achieve their low power consumption from the way they transmit data across the isolation barrier. By detecting the edge transitions of the input logic signal and converting these to narrow current pulses, a magnetic field is created around the GMR Wheatstone bridge. Depending on the direction of the magnetic field, the bridge causes the output comparator to switch following the input logic signal. Since the current pulses are narrow, about 2.5 ns, the power consumption is independent of mark-to-space ratio and solely dependent on frequency. This has obvious advantages over optocouplers, which have power consumption heavily dependent on mark-to-space ratio.

Power Supply Decoupling

Both power supplies should be decoupled with 0.1 μ F typical (0.047 μ F minimum) capacitors as close as possible to the V_{DD} pins. Ground planes for both GND_1 and GND_2 are highly recommended for data rates above 10 Mbps.

Signal Status on Start-Up and Shut Down

To minimize power dissipation, input signals are differentiated and then latched on the output side of the isolation barrier to reconstruct the signal. This could result in an ambiguous output state depending on power up, shutdown and power loss sequencing. Therefore, the designer should consider including an initialization signal in the start-up circuit. Initialization consists of toggling the input either high then low, or low then high.

Data Transmission Rates

The reliability of a transmission system is directly related to the accuracy and quality of the transmitted digital information. For a digital system, those parameters which determine the limits of the data transmission are pulse width distortion and propagation delay skew.

Propagation delay is the time taken for the signal to travel through the device. This is usually different when sending a low-to-high than when sending a high-to-low signal. This difference, or error, is called pulse width distortion (PWD) and is usually in nanoseconds. It may also be expressed as a percentage:

$$\text{PWD\%} = \frac{\text{Maximum Pulse Width Distortion (ns)}}{\text{Signal Pulse Width (ns)}} \times 100\%$$

For example, with data rates of 12.5 Mbps:

$$\text{PWD\%} = \frac{3 \text{ ns}}{80 \text{ ns}} \times 100\% = 3.75\%$$

This figure is almost **three times** better than any available optocoupler with the same temperature range, and **two times** better than any optocoupler regardless of published temperature range. IsoLoop isolators exceed the 10% maximum PWD recommended by PROFIBUS, and will run to nearly 35 Mb within the 10% limit.

Propagation delay skew is the signal propagation difference between two or more channels. This becomes significant in clocked systems because it is undesirable for the clock pulse to arrive before the data has settled. Short propagation delay skew is therefore especially critical in high data rate parallel systems for establishing and maintaining accuracy and repeatability. Worst-case channel-to-channel skew in an IL700 Isolator is only 3 ns, which is **ten times** better than any optocoupler. IL700 Isolators have a maximum propagation delay skew of 6 ns, which is **five times** better than any optocoupler.

Application Diagrams

Isolated PROFIBUS / RS-485

NVE offers a unique line of single-chip isolated PROFIBUS/RS-485 transceivers, but as this circuit illustrates, IL710 isolators can also be used as part of multi-chip designs using non-isolated PROFIBUS transceivers:

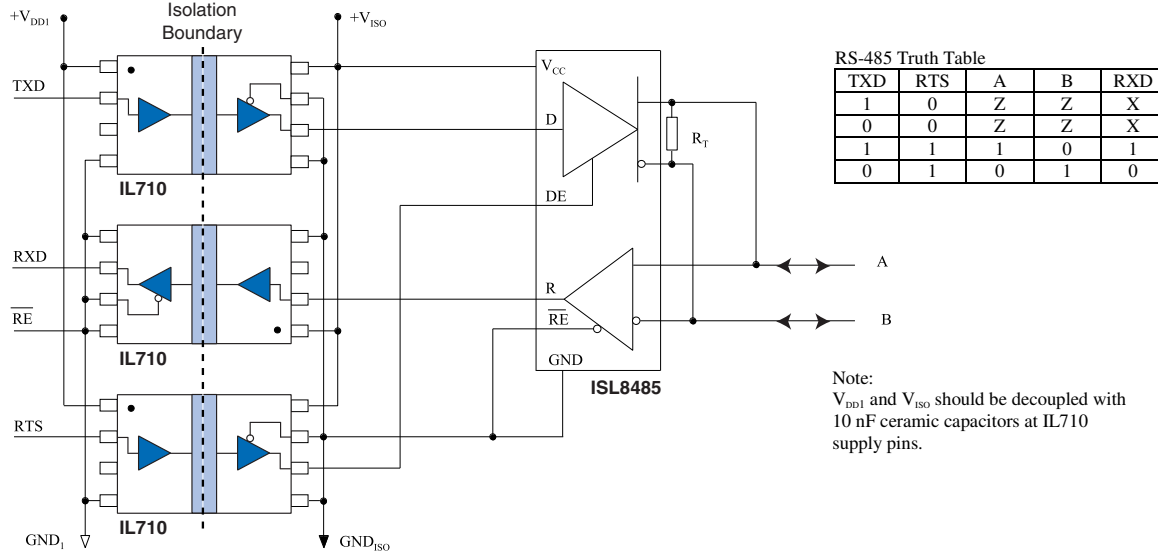

Isolated USB

In this circuit, power is supplied by USB bus power on one side of the isolation barrier, and the USB node's external supply on the other side of the barrier. IL700 Isolators are specified with just 3 ns worst-case pulse width distortion:

All power supplied by USB node's external supply on this side of isolation boundary

Power supplied by USB bus power this side of isolation boundary

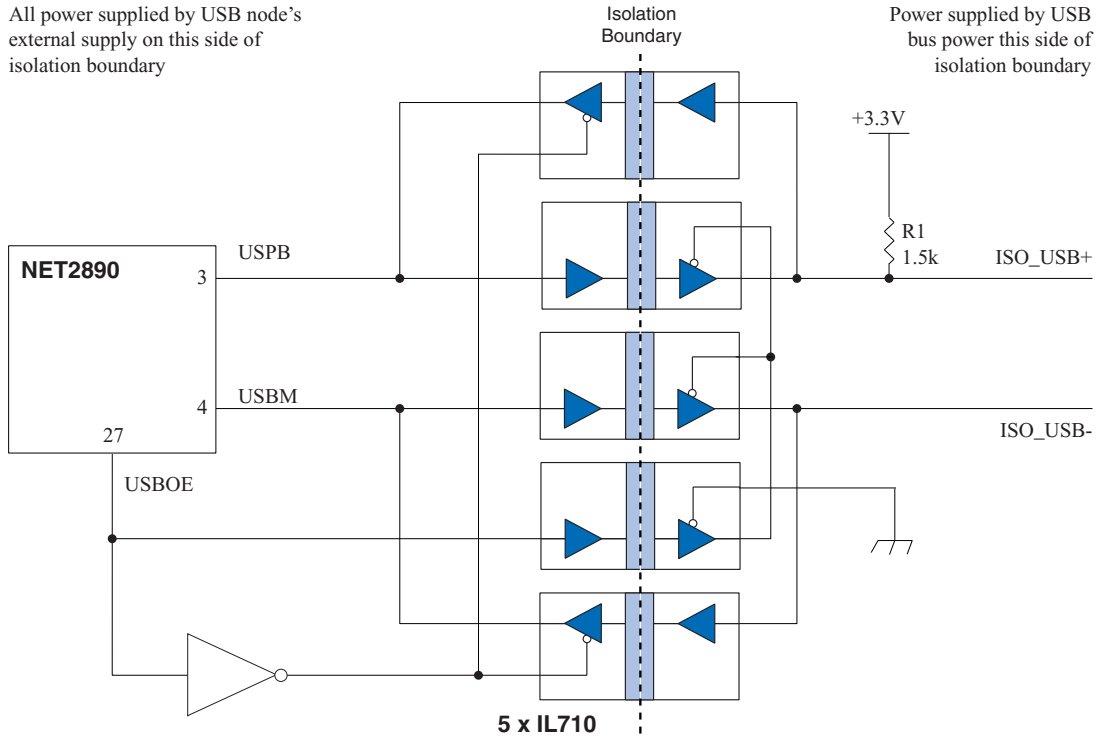

Package Drawings

8-pin MSOP (-1 suffix)

Dimensions in inches (mm); scale = approx. 5X

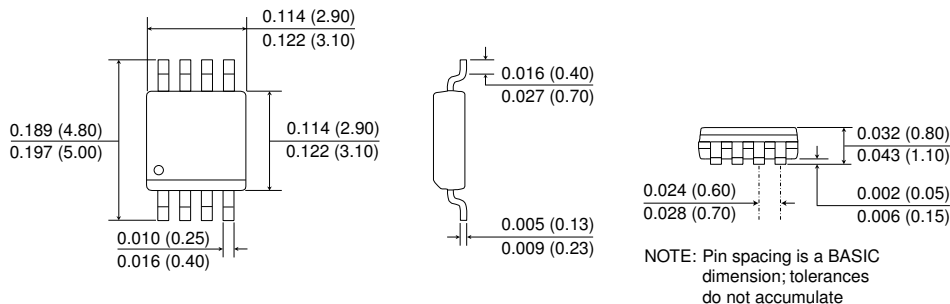

8-pin SOIC Package (-3 suffix)

Dimensions in inches (mm); scale = approx. 5X

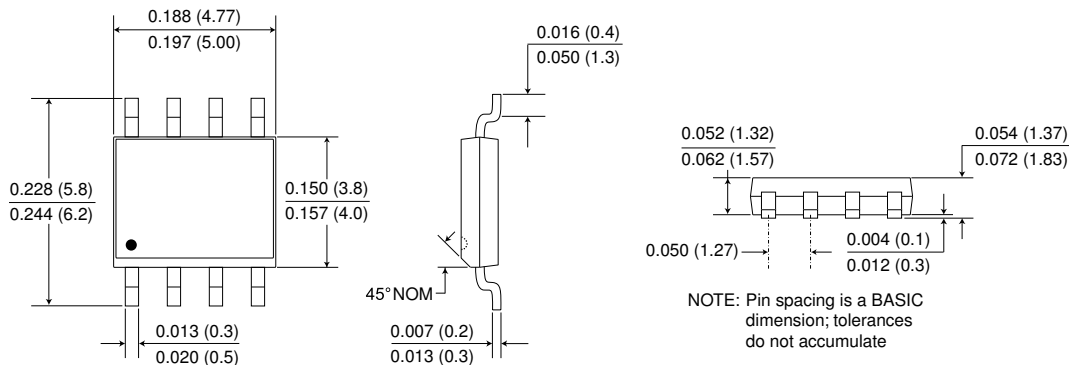

8-pin PDIP (-2 suffix)

Dimensions in inches (mm); scale = approx. 2.5X

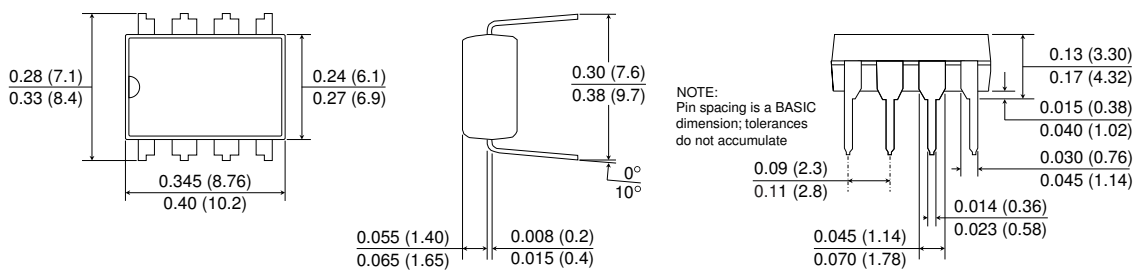

Recommended Pad Layouts

8-pin MSOP Pad Layout

Dimensions in inches (mm); scale = approx. 5X

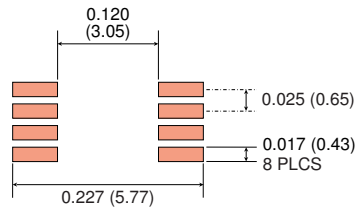

8-pin SOIC Pad Layout

Dimensions in inches (mm); scale = approx. 5X

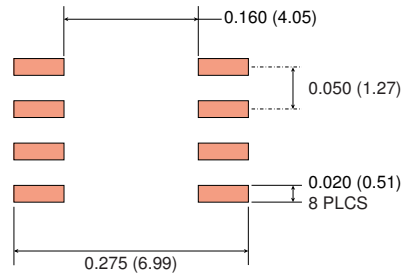



IL710

Ordering Information and Valid Part Numbers

IL 710 T - 3 E TR13

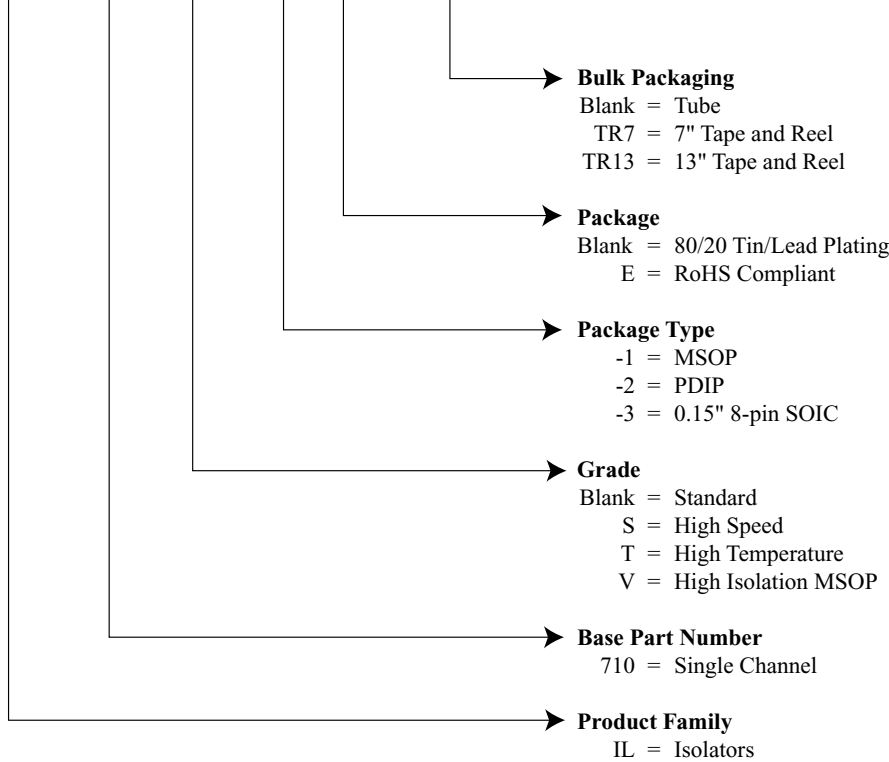

Valid Part Numbers

IL710-1E
 IL710S-1E
 IL710T-1E
 IL710V-1E

IL710-2
 IL710T-2
 IL710-2E
 IL710T-2E

IL710-3
 IL710S-3
 IL710T-3
 IL710-3E
 IL710S-3E
 IL710T-3E

All MSOP and SOIC parts are available on tape and reel.

ISB-DS-001-IL710-AH
November 2020

Changes

- Upgraded CMTI specifications.
- Added ATEC / IEC 60079 Intrinsic Safety pending (p. 3).
- Added output-side dynamic power consumption specifications (pp. 5 and 6).
- Changed “Propagation Delay Skew” to “Propagation Delay difference between any two parts” for clarity (pp. 5 and 6).

ISB-DS-001-IL710-AG

Changes

- Extended minimum operating power supplies to 2.7 volts.
- Updated EMC standards.
- Deleted minimum magnetic field immunity specifications since it is not 100% tested.
- Changed PDIP creepage specification from 7.04 mm to 6.8 mm (p. 6).
- Revised thermal properties (p. 6).
- Added Typical Performance Graphs (p. 7).
- More detailed description of operation (p. 8).

ISB-DS-001-IL710-AF

Change

- Updated SOIC8 package outline drawing.

ISB-DS-001-IL710-AE

Change

- Updated VDE approvals to VDE V 0884-10.

ISB-DS-001-IL710-AD

Change

- Added MSOP V-Series version (2500 VRMS isolation).

ISB-DS-001-IL710-AC

Changes

- Added product illustrations to first page.
- Revised and added details to thermal specifications (p. 2).
- Added VDE 0884 Safety-Limiting Values (p. 3).

ISB-DS-001-IL710-AB

Change

- IEC 60747-5-5 (VDE 0884) certification.

ISB-DS-001-IL710-AA

Changes

- Tighter quiescent current specifications.
- Upgraded from MSL 2 to MSL 1.

ISB-DS-001-IL710-Z

Changes

- Increased transient immunity specifications based on additional data.
- Added VDE 0884 pending.
- Added high voltage endurance specification.
- Increased magnetic immunity specifications.
- Updated package drawings.
- Added recommended solder pad layouts.

ISB-DS-001-IL710-Y

Changes

- Detailed isolation and barrier specifications.
- Cosmetic changes.

ISB-DS-001-IL710-X

Changes

- Tightened typ. output quiescent supply spec. from 1.7 mA to 1.5 mA.
- T-Series quiescent supply specs. tightened to be the same as other grades.

Datasheet Limitations

The information and data provided in datasheets shall define the specification of the product as agreed between NVE and its customer, unless NVE and customer have explicitly agreed otherwise in writing. All specifications are based on NVE test protocols. In no event however, shall an agreement be valid in which the NVE product is deemed to offer functions and qualities beyond those described in the datasheet.

Limited Warranty and Liability

Information in this document is believed to be accurate and reliable. However, NVE does not give any representations or warranties, expressed or implied, as to the accuracy or completeness of such information and shall have no liability for the consequences of use of such information.

In no event shall NVE be liable for any indirect, incidental, punitive, special or consequential damages (including, without limitation, lost profits, lost savings, business interruption, costs related to the removal or replacement of any products or rework charges) whether or not such damages are based on tort (including negligence), warranty, breach of contract or any other legal theory.

Right to Make Changes

NVE reserves the right to make changes to information published in this document including, without limitation, specifications and product descriptions at any time and without notice. This document supersedes and replaces all information supplied prior to its publication.

Use in Life-Critical or Safety-Critical Applications

Unless NVE and a customer explicitly agree otherwise in writing, NVE products are not designed, authorized or warranted to be suitable for use in life support, life-critical or safety-critical devices or equipment. NVE accepts no liability for inclusion or use of NVE products in such applications and such inclusion or use is at the customer's own risk. Should the customer use NVE products for such application whether authorized by NVE or not, the customer shall indemnify and hold NVE harmless against all claims and damages.

Applications

Applications described in this datasheet are illustrative only. NVE makes no representation or warranty that such applications will be suitable for the specified use without further testing or modification.

Customers are responsible for the design and operation of their applications and products using NVE products, and NVE accepts no liability for any assistance with applications or customer product design. It is customer's sole responsibility to determine whether the NVE product is suitable and fit for the customer's applications and products planned, as well as for the planned application and use of customer's third party customers. Customers should provide appropriate design and operating safeguards to minimize the risks associated with their applications and products.

NVE does not accept any liability related to any default, damage, costs or problem which is based on any weakness or default in the customer's applications or products, or the application or use by customer's third party customers. The customer is responsible for all necessary testing for the customer's applications and products using NVE products in order to avoid a default of the applications and the products or of the application or use by customer's third party customers. NVE accepts no liability in this respect.

Limiting Values

Stress above one or more limiting values (as defined in the Absolute Maximum Ratings System of IEC 60134) will cause permanent damage to the device. Limiting values are stress ratings only and operation of the device at these or any other conditions above those given in the recommended operating conditions of the datasheet is not warranted. Constant or repeated exposure to limiting values will permanently and irreversibly affect the quality and reliability of the device.

Terms and Conditions of Sale

In case an individual agreement is concluded only the terms and conditions of the respective agreement shall apply. NVE hereby expressly objects to applying the customer's general terms and conditions with regard to the purchase of NVE products by customer.

No Offer to Sell or License

Nothing in this document may be interpreted or construed as an offer to sell products that is open for acceptance or the grant, conveyance or implication of any license under any copyrights, patents or other industrial or intellectual property rights.

Export Control

This document as well as the items described herein may be subject to export control regulations. Export might require a prior authorization from national authorities.

Automotive Qualified Products

Unless the datasheet expressly states that a specific NVE product is automotive qualified, the product is not suitable for automotive use. It is neither qualified nor tested in accordance with automotive testing or application requirements. NVE accepts no liability for inclusion or use of non-automotive qualified products in automotive equipment or applications.

In the event that customer uses the product for design-in and use in automotive applications to automotive specifications and standards, customer (a) shall use the product without NVE's warranty of the product for such automotive applications, use and specifications, and (b) whenever customer uses the product for automotive applications beyond NVE's specifications such use shall be solely at customer's own risk, and (c) customer fully indemnifies NVE for any liability, damages or failed product claims resulting from customer design and use of the product for automotive applications beyond NVE's standard warranty and NVE's product specifications.

©NVE Corporation

All rights are reserved. Reproduction in whole or in part is prohibited without the prior written consent of the copyright owner.

ISB-DS-001-IL710-AH

November 2020

We are here for you. Addresses and Contacts.

Headquarter Switzerland:

Angst+Pfister Sensors and Power AG
Thurgauerstrasse 66
CH-8050 Zurich
Phone +41 44 877 35 00
sensorsandpower@angst-pfister.com

Office Germany:

Angst+Pfister Sensors and Power Deutschland GmbH
Edisonstraße 16
D-85716 Unterschleißheim
Phone +49 89 374 288 87 00
sensorsandpower.de@angst-pfister.com

Scan here and get an overview of personal contacts!



sensorsandpower.angst-pfister.com
