

## DATASHEET

## UJ4SC075006K4S

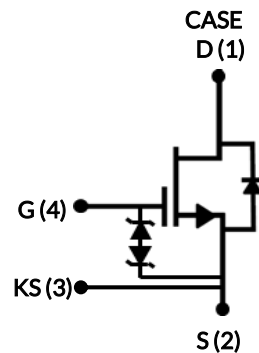

## 750V-5.9mΩ SiC FET

Rev. B, July 2021

## Description

The UJ4SC075006K4S is a 750V, 5.9mΩ G4 SiC FET. It is based on a unique 'cascode' circuit configuration, in which a normally-on SiC JFET is co-packaged with a Si MOSFET to produce a normally-off SiC FET device. The device's standard gate-drive characteristics allows for a true "drop-in replacement" to Si IGBTs, Si FETs, SiC MOSFETs or Si superjunction devices. Available in the TO-247-4L package, this device exhibits ultra-low gate charge and exceptional reverse recovery characteristics, making it ideal for switching inductive loads and any application requiring standard gate drive.

## Features

- On-resistance  $R_{DS(on)}$ : 5.9mΩ (typ)
- Operating temperature: 175°C (max)
- Excellent reverse recovery:  $Q_{rr}$  = 440nC
- Low body diode  $V_{FSD}$ : 1.03V
- Low gate charge:  $Q_G$  = 164nC
- Threshold voltage  $V_{G(th)}$ : 4.7V (typ) allowing 0 to 15V drive
- Low intrinsic capacitance
- ESD protected, HBM class 2
- TO-247-4L package for faster switching, clean gate waveforms

Part Number	Package	Marking
UJ4SC075006K4S	TO-247-4L	UJ4SC075006K4S

## Typical applications

- EV charging
- PV inverters
- Switch mode power supplies
- Power factor correction modules
- Motor drives
- Induction heating



## Maximum Ratings

Parameter	Symbol	Test Conditions	Value	Units
Drain-source voltage	$V_{DS}$		750	V
Gate-source voltage	$V_{GS}$	DC	-20 to +20	V
		AC (f > 1Hz)	-25 to +25	V
Continuous drain current <sup>1</sup>	$I_D$	$T_C < 125^\circ\text{C}$	120	A
Pulsed drain current <sup>2</sup>	$I_{DM}$	$T_C = 25^\circ\text{C}$	588	A
Single pulsed avalanche energy <sup>3</sup>	$E_{AS}$	L=15mH, $I_{AS} = 6.5\text{A}$	316	mJ
Short circuit withstand time <sup>4</sup>	$t_{SC}$	$V_{DS} = 400\text{V}$ , $T_{J(\text{START})} = 175^\circ\text{C}$	5	$\mu\text{s}$
SiC FET dv/dt ruggedness	dv/dt	$V_{DS} \leq 500\text{V}$	100	V/ns
Power dissipation	$P_{tot}$	$T_C = 25^\circ\text{C}$	714	W
Maximum junction temperature	$T_{J,max}$		175	$^\circ\text{C}$
Operating and storage temperature	$T_J, T_{STG}$		-55 to 175	$^\circ\text{C}$
Max. lead temperature for soldering, 1/8" from case for 5 seconds	$T_L$		250	$^\circ\text{C}$

1. Limited by bondwires

2. Pulse width  $t_p$  limited by  $T_{J,max}$

3. Starting  $T_J = 25^\circ\text{C}$

4. Short circuit current is independent of the gate voltage  $V_{GS} > 12\text{V}$

## Thermal Characteristics

Parameter	Symbol	Test Conditions	Value			Units
			Min	Typ	Max	
Thermal resistance, junction-to-case	$R_{\theta JC}$			0.16	0.21	$^\circ\text{C/W}$

## Electrical Characteristics ( $T_J = +25^\circ\text{C}$ unless otherwise specified)

### Typical Performance - Static

Parameter	Symbol	Test Conditions	Value			Units
			Min	Typ	Max	
Drain-source breakdown voltage	$BV_{DS}$	$V_{GS}=0V, I_D=1mA$	750			V
Total drain leakage current	$I_{DSS}$	$V_{DS}=750V,$ $V_{GS}=0V, T_J=25^\circ\text{C}$		6	130	$\mu\text{A}$
		$V_{DS}=750V,$ $V_{GS}=0V, T_J=175^\circ\text{C}$		45		
Total gate leakage current	$I_{GSS}$	$V_{DS}=0V, T_J=25^\circ\text{C},$ $V_{GS}=-20V / +20V$		6	$\pm 20$	$\mu\text{A}$
Drain-source on-resistance	$R_{DS(on)}$	$V_{GS}=12V, I_D=80A,$ $T_J=25^\circ\text{C}$		5.9	7.4	m $\Omega$
		$V_{GS}=12V, I_D=80A,$ $T_J=125^\circ\text{C}$		9.8		
		$V_{GS}=12V, I_D=80A,$ $T_J=175^\circ\text{C}$		12.9		
Gate threshold voltage	$V_{G(th)}$	$V_{DS}=5V, I_D=10mA$	4	4.7	6	V
Gate resistance	$R_G$	$f=1MHz, \text{open drain}$		0.8	1.5	$\Omega$

### Typical Performance - Reverse Diode

Parameter	Symbol	Test Conditions	Value			Units
			Min	Typ	Max	
Diode continuous forward current <sup>1</sup>	$I_S$	$T_C < 125^\circ\text{C}$			120	A
Diode pulse current <sup>2</sup>	$I_{S,pulse}$	$T_C=25^\circ\text{C}$			588	A
Forward voltage	$V_{FSD}$	$V_{GS}=0V, I_F=50A,$ $T_J=25^\circ\text{C}$		1.03	1.16	V
		$V_{GS}=0V, I_F=50A,$ $T_J=175^\circ\text{C}$		1.06		
Reverse recovery charge	$Q_{rr}$	$V_R=400V, I_F=80A,$ $V_{GS}=0V, R_{G\_EXT}=5\Omega$ $di/dt=2800A/\mu\text{s},$ $T_J=25^\circ\text{C}$		440		nC
Reverse recovery time	$t_{rr}$	$V_R=400V, I_F=80A,$ $V_{GS}=0V, R_{G\_EXT}=5\Omega$ $di/dt=2800A/\mu\text{s},$ $T_J=25^\circ\text{C}$		31		ns
Reverse recovery charge	$Q_{rr}$	$V_R=400V, I_F=80A,$ $V_{GS}=0V, R_{G\_EXT}=5\Omega$ $di/dt=2800A/\mu\text{s},$ $T_J=150^\circ\text{C}$		525		nC
Reverse recovery time	$t_{rr}$	$V_R=400V, I_F=80A,$ $V_{GS}=0V, R_{G\_EXT}=5\Omega$ $di/dt=2800A/\mu\text{s},$ $T_J=150^\circ\text{C}$		37		ns

## Typical Performance - Dynamic

Parameter	Symbol	Test Conditions	Value			Units	
			Min	Typ	Max		
Input capacitance	$C_{iss}$	$V_{DS}=400V, V_{GS}=0V$ $f=100kHz$		8374		pF	
Output capacitance	$C_{oss}$			362			
Reverse transfer capacitance	$C_{rss}$			4			
Effective output capacitance, energy related	$C_{oss(er)}$	$V_{DS}=0V$ to 400V, $V_{GS}=0V$		475		pF	
Effective output capacitance, time related	$C_{oss(tr)}$	$V_{DS}=0V$ to 400V, $V_{GS}=0V$		950		pF	
$C_{oss}$ stored energy	$E_{oss}$	$V_{DS}=400V, V_{GS}=0V$		38		$\mu J$	
Total gate charge	$Q_G$	$V_{DS}=400V, I_D=80A,$ $V_{GS} = -0V$ to 15V		164		nC	
Gate-drain charge	$Q_{GD}$			24			
Gate-source charge	$Q_{GS}$			46			
Turn-on delay time	$t_{d(on)}$	Notes 5 and 6, $V_{DS}=400V, I_D=80A,$ Gate Driver =0V to +15V, Turn-on $R_{G,EXT}=1.5\Omega,$ Turn-off $R_{G,EXT}=5\Omega,$ inductive Load, FWD: same device with $V_{GS} = 0V$ and $R_G = 5\Omega,$ RC snubber: $R_S=5\Omega$ and $C_S=680pF,$ $T_J=25^\circ C$		37		ns	
Rise time	$t_r$			40			
Turn-off delay time	$t_{d(off)}$			110			
Fall time	$t_f$			13			
Turn-on energy including $R_S$ energy	$E_{ON}$				514		$\mu J$
Turn-off energy including $R_S$ energy	$E_{OFF}$				170		
Total switching energy	$E_{TOTAL}$				684		
Snubber $R_S$ energy during turn-on	$E_{RS\_ON}$				9.6		
Snubber $R_S$ energy during turn-off	$E_{RS\_OFF}$				50		
Turn-on delay time	$t_{d(on)}$		Notes 5 and 6, $V_{DS}=400V, I_D=80A,$ Gate Driver =0V to +15V, Turn-on $R_{G,EXT}=1.5\Omega,$ Turn-off $R_{G,EXT}=5\Omega,$ inductive Load, FWD: same device with $V_{GS} = 0V$ and $R_G = 5\Omega,$ RC snubber: $R_S=5\Omega$ and $C_S=680pF,$ $T_J=150^\circ C$		36		ns
Rise time	$t_r$			44			
Turn-off delay time	$t_{d(off)}$			121			
Fall time	$t_f$			16			
Turn-on energy including $R_S$ energy	$E_{ON}$				640		$\mu J$
Turn-off energy including $R_S$ energy	$E_{OFF}$				189		
Total switching energy	$E_{TOTAL}$				829		
Snubber $R_S$ energy during turn-on	$E_{RS\_ON}$				9		
Snubber $R_S$ energy during turn-off	$E_{RS\_OFF}$				51		

5. Measured with the switching test circuit in Figure 29.

6. In this datasheet, all the switching energies (turn-on energy, turn-off energy and total energy) presented in the tables and Figures include the device RC snubber energy losses.



Typical Performance Diagrams

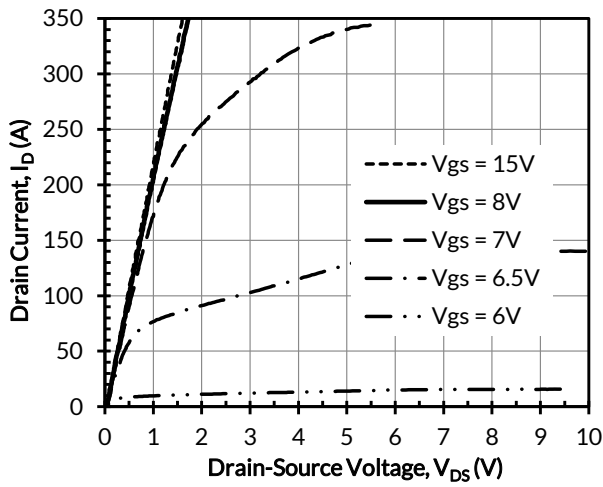

Figure 1. Typical output characteristics at  $T_j = -55^\circ\text{C}$ ,  $t_p < 250\mu\text{s}$

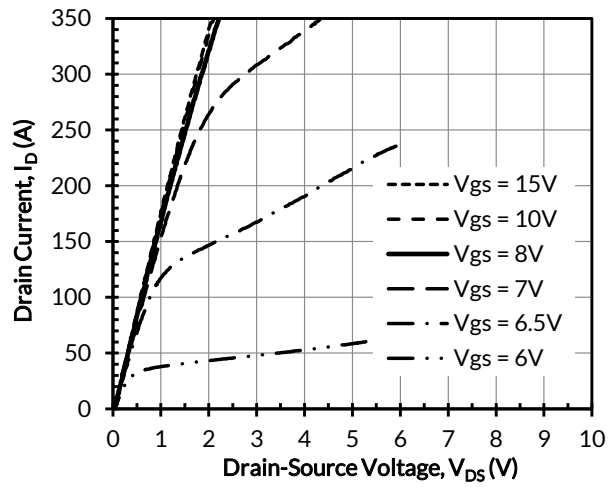

Figure 2. Typical output characteristics at  $T_j = 25^\circ\text{C}$ ,  $t_p < 250\mu\text{s}$

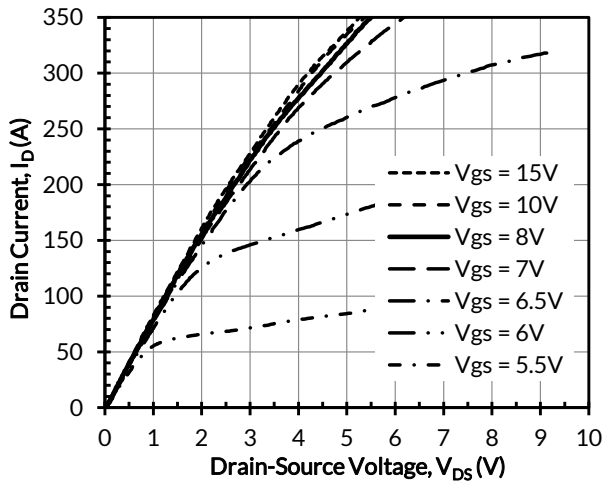

Figure 3. Typical output characteristics at  $T_j = 175^\circ\text{C}$ ,  $t_p < 250\mu\text{s}$

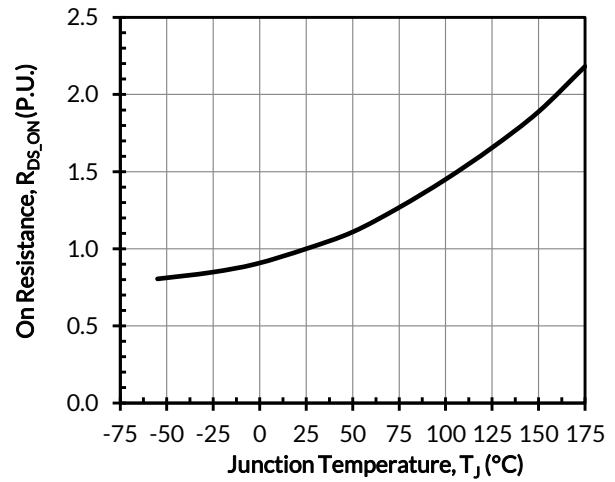

Figure 4. Normalized on-resistance vs. temperature at  $V_{GS} = 12\text{V}$  and  $I_D = 80\text{A}$

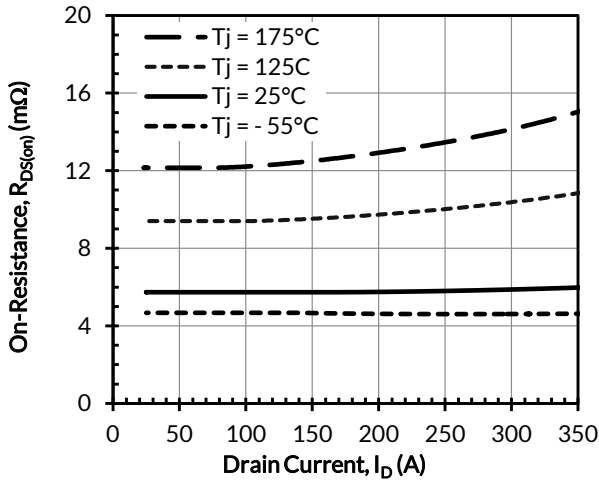

Figure 5. Typical drain-source on-resistances at  $V_{GS} = 12V$

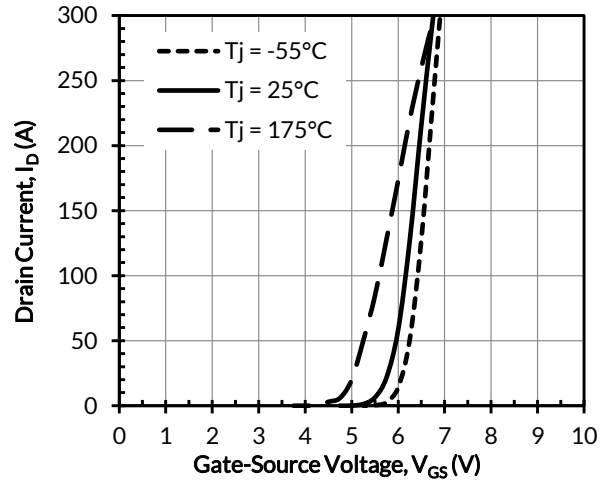

Figure 6. Typical transfer characteristics at  $V_{DS} = 5V$

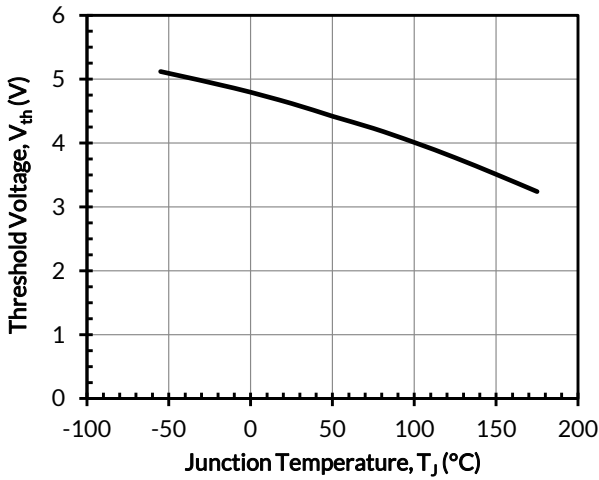

Figure 7. Threshold voltage vs. junction temperature at  $V_{DS} = 5V$  and  $I_D = 10mA$

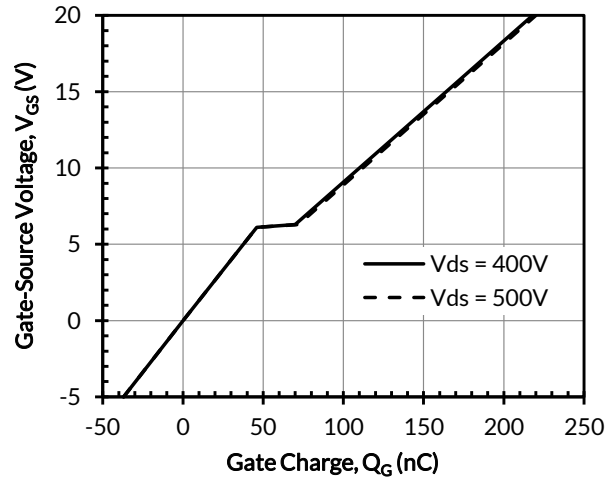

Figure 8. Typical gate charge at  $I_D = 80A$

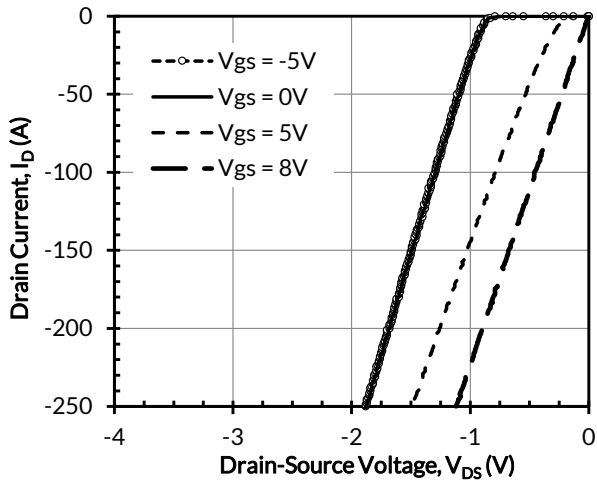

Figure 9. 3rd quadrant characteristics at  $T_j = -55^\circ\text{C}$

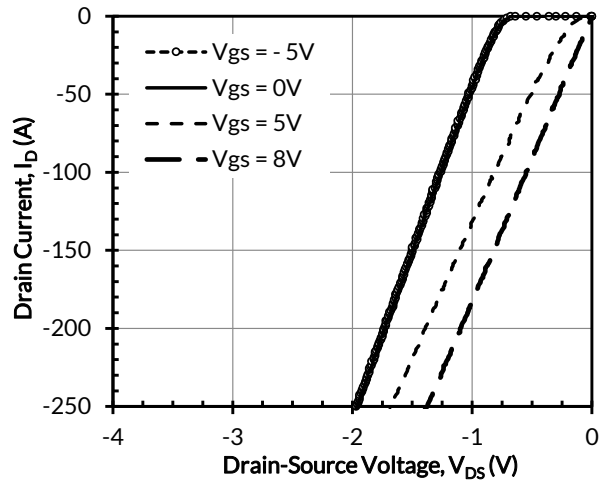

Figure 10. 3rd quadrant characteristics at  $T_j = 25^\circ\text{C}$

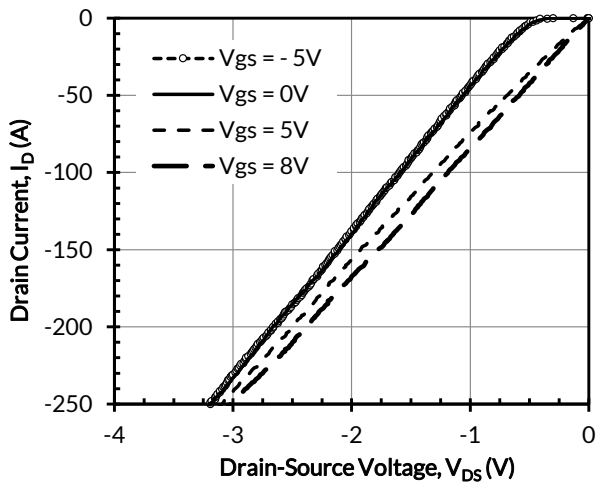

Figure 11. 3rd quadrant characteristics at  $T_j = 175^\circ\text{C}$

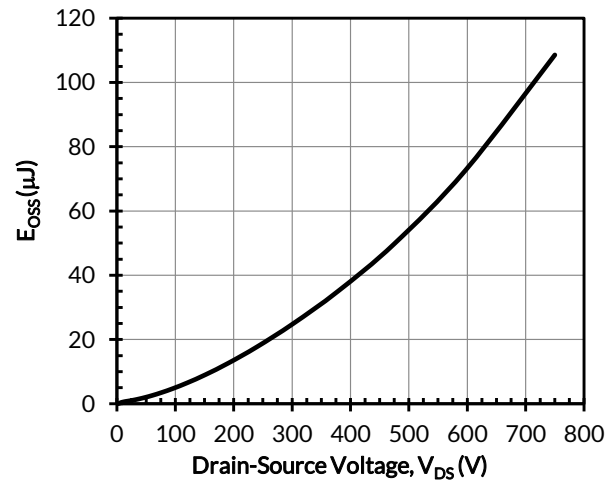

Figure 12. Typical stored energy in  $C_{OSS}$  at  $V_{GS} = 0\text{V}$

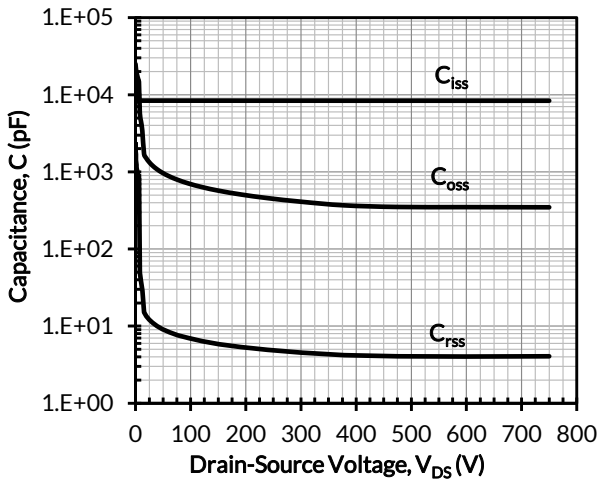

Figure 13. Typical capacitances at  $f = 100\text{kHz}$  and  $V_{GS} = 0\text{V}$

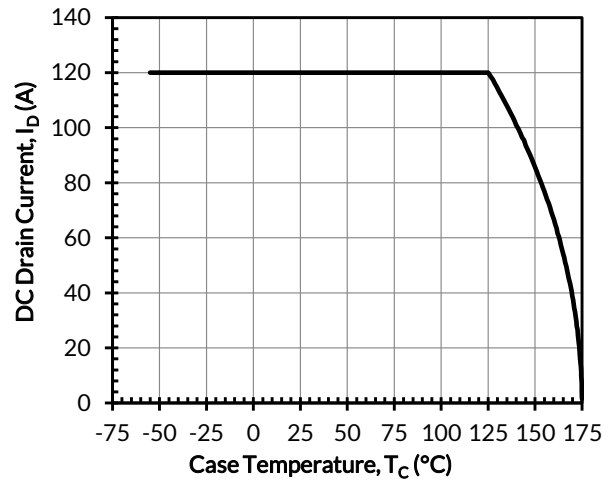

Figure 14. DC drain current derating

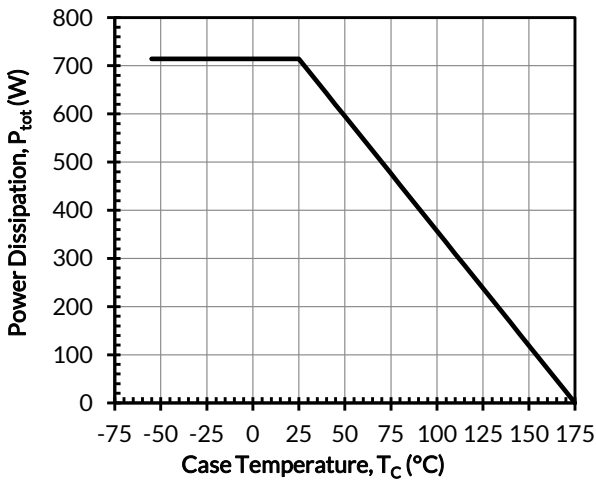

Figure 15. Total power dissipation

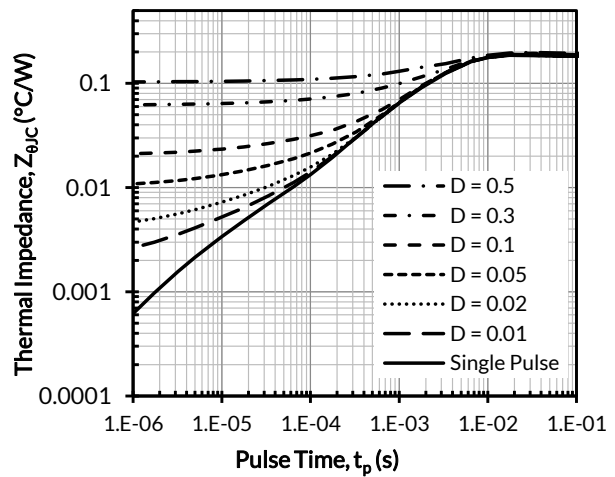

Figure 16. Maximum transient thermal impedance



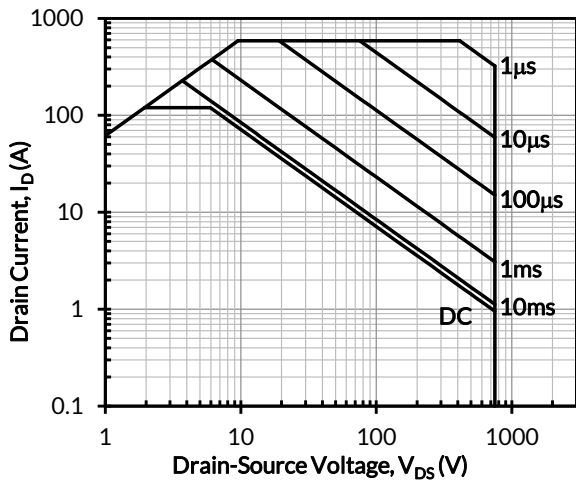

Figure 17. Safe operation area at  $T_C = 25^\circ\text{C}$ ,  $D = 0$ , Parameter  $t_p$

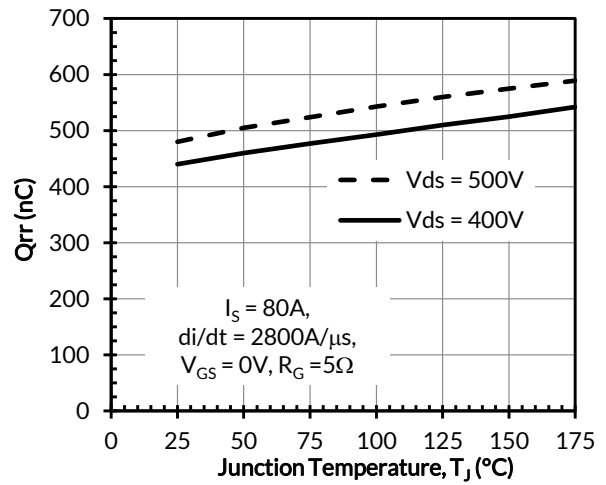

Figure 18. Reverse recovery charge  $Q_{rr}$  vs. junction temperature

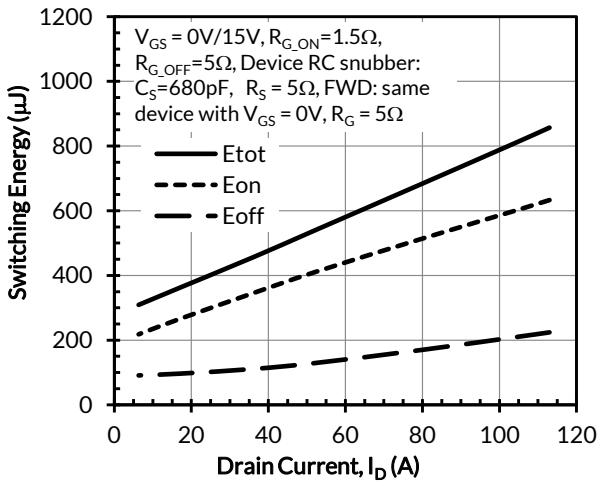

Figure 19. Clamped inductive switching energy vs. drain current at  $V_{DS} = 400\text{V}$  and  $T_J = 25^\circ\text{C}$

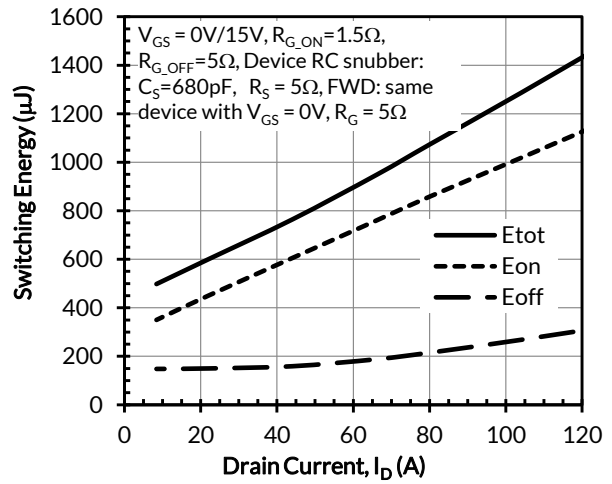

Figure 20. Clamped inductive switching energy vs. drain current at  $V_{DS} = 500\text{V}$  and  $T_J = 25^\circ\text{C}$

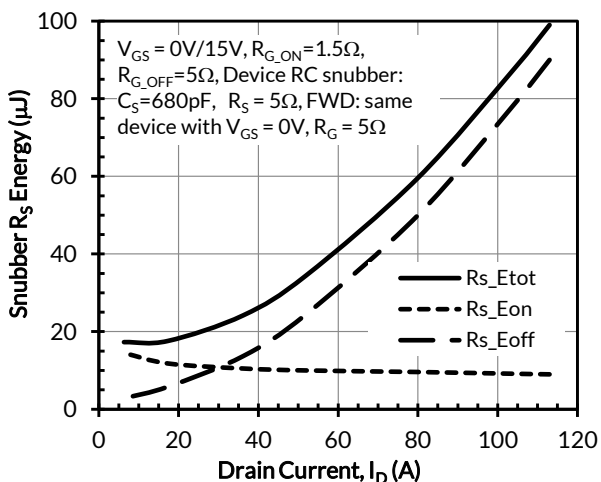

Figure 21. RC snubber energy loss vs. drain current at  $V_{DS} = 400V$  and  $T_J = 25^\circ C$

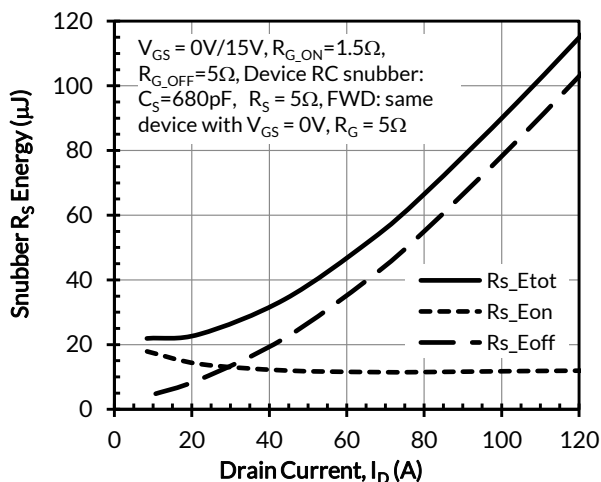

Figure 22. RC snubber energy losses vs. drain current at  $V_{DS} = 500V$  and  $T_J = 25^\circ C$

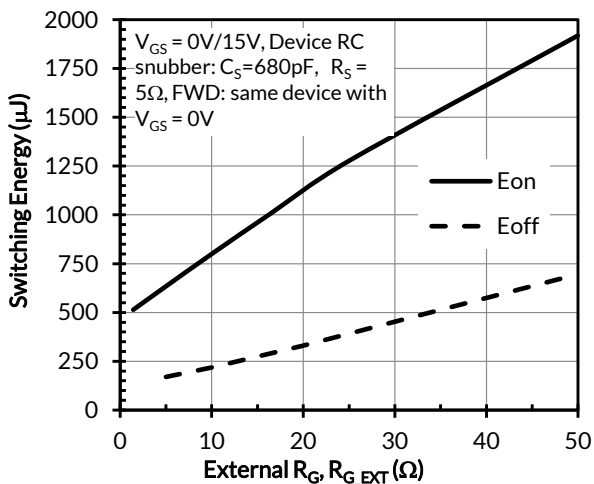

Figure 23. Clamped inductive switching energies vs.  $R_{G,EXT}$  at  $V_{DS} = 400V$ ,  $I_D = 80A$ , and  $T_J = 25^\circ C$

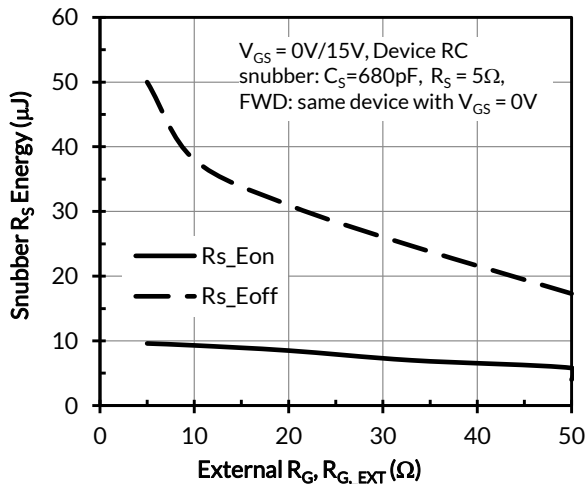

Figure 24. RC snubber energy losses vs.  $R_{G,EXT}$  at  $V_{DS} = 400V$ ,  $I_D = 80A$ , and  $T_J = 25^\circ C$

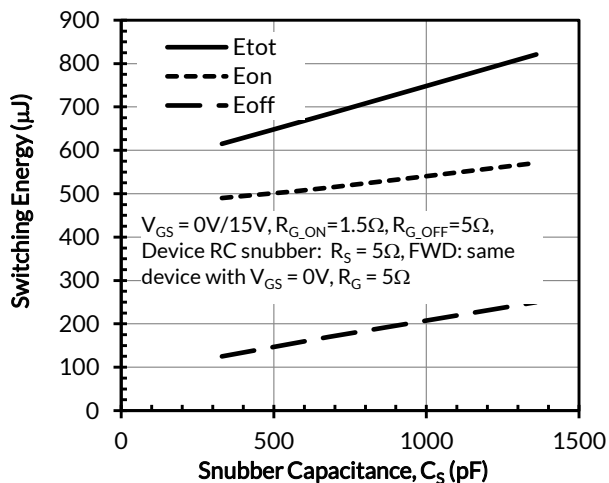

Figure 25. Clamped inductive switching energies vs. snubber capacitance  $C_S$  at  $V_{DS} = 400V$ ,  $I_D = 80A$ , and  $T_J = 25^\circ C$

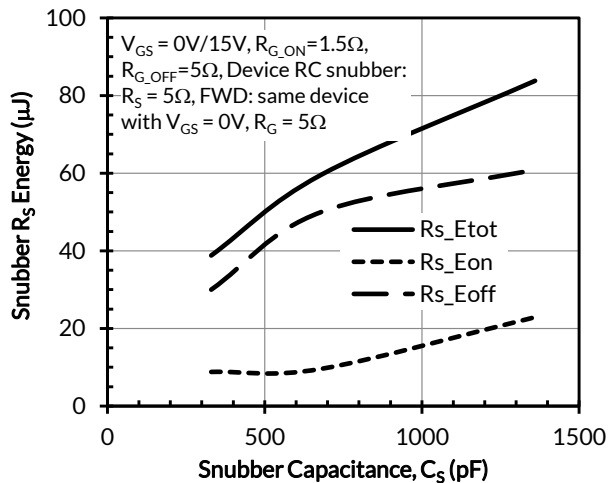

Figure 26. RC snubber energy losses vs. snubber capacitance  $C_S$  at  $V_{DS} = 400V$ ,  $I_D = 80A$ , and  $T_J = 25^\circ C$

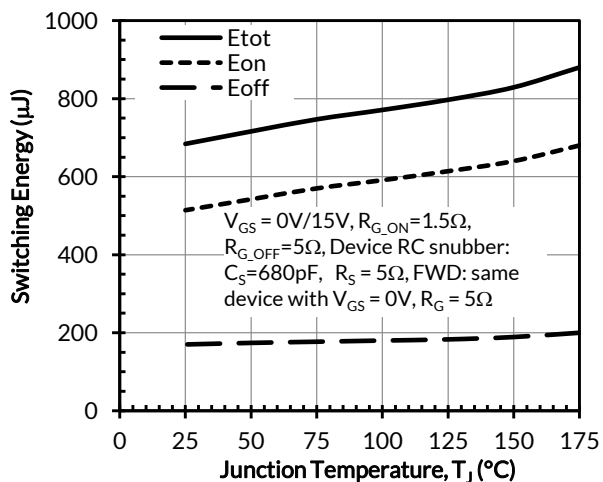

Figure 27. Clamped inductive switching energy vs. junction temperature at  $V_{DS} = 400V$  and  $I_D = 80A$

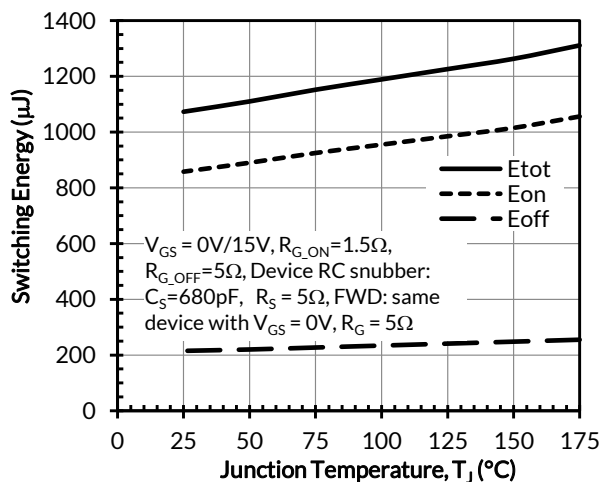

Figure 28. Clamped inductive switching energy vs. junction temperature at  $V_{DS} = 500V$  and  $I_D = 80A$

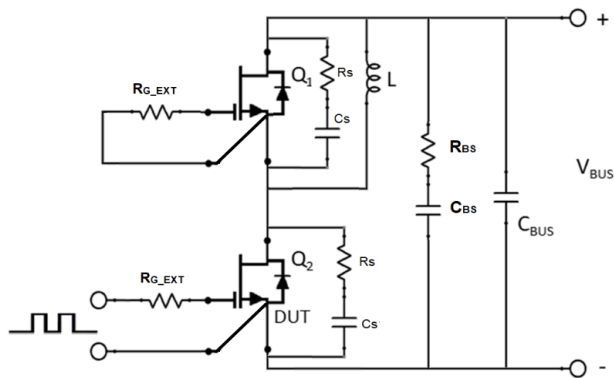

Figure 29. Schematic of the half-bridge mode switching test circuit. Note, a bus RC snubber ( $R_{BS} = 1\Omega$ ,  $C_{BS} = 100\text{nF}$ ) is used to reduce the power loop high frequency oscillations.

## Applications Information

SiC FETs are enhancement-mode power switches formed by a high-voltage SiC depletion-mode JFET and a low-voltage silicon MOSFET connected in series. The silicon MOSFET serves as the control unit while the SiC JFET provides high voltage blocking in the off state. This combination of devices in a single package provides compatibility with standard gate drivers and offers superior performance in terms of low on-resistance ( $R_{DS(on)}$ ), output capacitance ( $C_{oss}$ ), gate charge ( $Q_G$ ), and reverse recovery charge ( $Q_{rr}$ ) leading to low conduction and switching losses. The SiC FETs also provide excellent reverse conduction capability eliminating the need for an external anti-parallel diode.

Like other high performance power switches, proper PCB layout design to minimize circuit parasitics is strongly recommended due to the high  $dv/dt$  and  $di/dt$  rates. An external gate resistor is recommended when the FET is working in the diode mode in order to achieve the optimum reverse recovery performance. For more information on SiC FET operation, see [www.unitedsic.com](http://www.unitedsic.com).

## Disclaimer

UnitedSiC reserves the right to change or modify any of the products and their inherent physical and technical specifications without prior notice. UnitedSiC assumes no responsibility or liability for any errors or inaccuracies within.

Information on all products and contained herein is intended for description only. No license, express or implied, to any intellectual property rights is granted within this document.

UnitedSiC assumes no liability whatsoever relating to the choice, selection or use of the UnitedSiC products and services described herein.

## We are here for you. Addresses and Contacts.

---

### Headquarter Switzerland:

Angst+Pfister Sensors and Power AG  
Thurgauerstrasse 66  
CH-8050 Zurich  
Phone +41 44 877 35 00  
[sensorsandpower@angst-pfister.com](mailto:sensorsandpower@angst-pfister.com)

### Office Germany:

Angst+Pfister Sensors and Power Deutschland GmbH  
Edisonstraße 16  
D-85716 Unterschleißheim  
Phone +49 89 374 288 87 00  
[sensorsandpower.de@angst-pfister.com](mailto:sensorsandpower.de@angst-pfister.com)

---

Scan here and get an overview of personal contacts!



[sensorsandpower.angst-pfister.com](https://sensorsandpower.angst-pfister.com)

---