

ADLxxx Nanopower Digital Switches

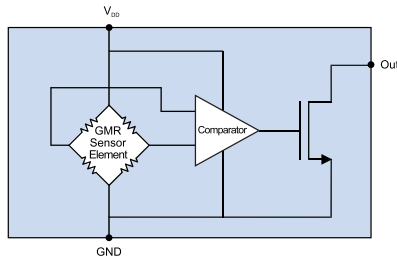

Functional Diagrams



ADL9xx
(continuous duty)

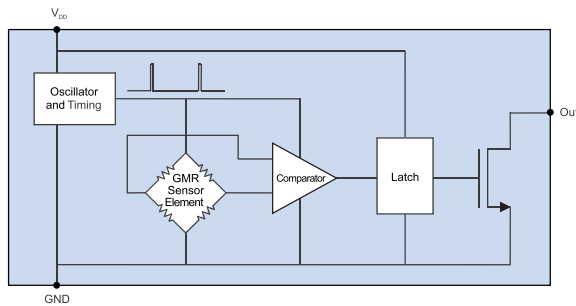

ADL0xx
(duty-cycled)

Magnetic Responses

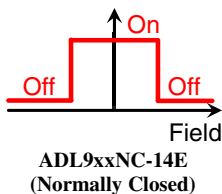
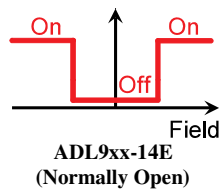

Features

- 2.4 V to 4.2 V operating voltage
- Continuously operating or duty-cycled versions
- Power as low as 84 nW (ADL1xx; $V_{DD} = 2.4$ V)
- Operate points as low as 1 mT (10 Oe)
- Normally-open or normally-closed outputs
- Precise detection of low magnetic fields
- Ultraminiature 1.1 x 1.1 x 0.35 mm DFN4 package

Applications

- Primary lithium or rechargeable lithium-ion powered devices
- Proximity sensing
- Wearables
- Portable instruments
- 4 – 20 mA current loops

Description

ADLxxx-Series sensors are Giant Magnetostrictive (GMR) Digital Switches designed to operate from 3.3-volt power supplies or single lithium cells with extremely supply low currents. Their 4.2 volt maximum operating voltage accommodates lithium-ion rechargeable batteries.

The devices are manufactured with NVE's patented spintronic GMR technology and low-power CMOS circuitry for unmatched miniaturization, sensitivity, precision, and low power.

Versions are available that are either continuous duty or internally duty cycled operation to further reduce power consumption. An integrated latch ensures the output is available continuously in duty-cycled versions.

The outputs are configured as magnetic switches. Normally-open versions turn on (LOW output) when the magnetic field is applied and off (OPEN output) when the field is removed. Normally-closed versions turn off when a field is applied.

The applied field can be of either polarity, and the operate point is extremely stable over supply voltage and temperature. The output is current-sinking, and can sink up to 100 microamps.

Absolute Maximum Ratings

Parameter	Min.	Max.	Units
Supply voltage		5.5	Volts
Output voltage		5.5	Volts
Output current		200	μA
Storage temperature	-65	135	°C
Junction temperature		135	°C
Applied magnetic field		Unlimited	

Operating Specifications

T _{min} to T _{max} ; 2.4 V < V _{DD} < 4.2V unless otherwise stated.						
Parameter	Symbol	Min.	Typ.	Max.	Units	Test Condition
Supply voltage	V _{DD}	2.4	3	4.2	Volts	
Operating temperature	T _{MIN} ; T _{MAX}	-40		125	°C	
Magnetic operate point	B _{OP}	0.7	1	1.4	mT*	
ADLx25		1.4	2	2.5		
ADLx21		2.1	2.8	3.4		
ADLx24		3	4	5		
ADLx22						
Operate/release differential	B _{OP} -B _{REL}	0.05		0.8	mT*	
ADLx25		0.1		1.4		
ADLx21		0.1		1.4		
ADLx24		0.1		2.5		
ADLx22						
Quiescent current (output open)	I _{DDQ}		0.035	0.07	μA	V _{DD} = 2.4V
ADL1xx			0.05	0.1		
ADL0xx			35	50		
ADL9xx			0.08	0.16		V _{DD} = 3V
ADL1xx			0.095	0.19		
ADL0xx			60	100		
ADL9xx			0.12	0.24		V _{DD} = 3.6V
ADL1xx			0.14	0.28		
ADL0xx			85	120		
ADL9xx			0.24	0.3		V _{DD} = 4.2V
ADL1xx			0.32	0.4		
ADL0xx			140	200		
ADL9xx						
ADL0xx / ADL1xx peak supply current	I _{DD-PK}		60	100	μA	V _{DD} = 3V
Output drive current	I _{OL-ON}	100			μA	
Output low voltage	V _{OL}			0.2	V	V _{DD} = 3.6V; I _{OL-ON} = 100 μA
Output leakage current	I _{OL-OFF}			2	nA	V _{DD} = 3.6V
Update frequency						
ADL1xx		10	30		Hz	
ADL0xx		20	55			
Frequency response (ADL9xx)			100		kHz	

*1 mT = 10 Oe in air.

Operation

Direction of Magnetic Sensitivity

As the field varies in intensity, the digital output will turn on and off. Unlike Hall effect or other sensors, the direction of sensitivity is in the plane of the package. The diagrams below show two permanent magnet orientations that will activate the sensor in the direction of sensitivity:

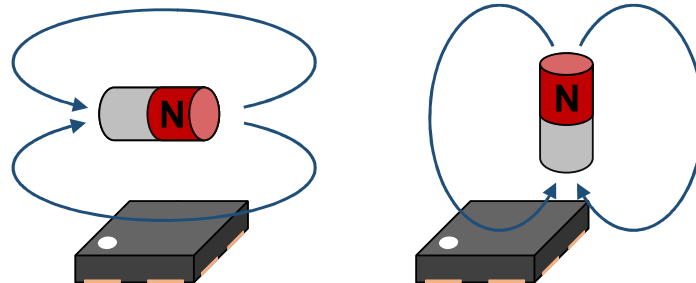

Figure 1. Direction of magnetic sensitivity.

ADL-Series sensors are “omnipolar,” meaning the outputs turn ON when a magnetic field of either magnetic polarity is applied.

External Pull-Up Resistor

Outputs are logic low when the sensor is activated. The outputs are open-drain, and should have an external pull-up resistor. For microcontroller interfaces, the microcontroller’s input pull-up resistors can be activated (note that with a 3.3-volt supply, the pull-up resistor should be a minimum of 33 k Ω for compatibility with the sensor’s 100 μ A output current).

Typical Operation

Figure 2 shows typical ADL-Series sensor orientation. The arrow on the circuit board shows the direction of magnetic sensitivity:

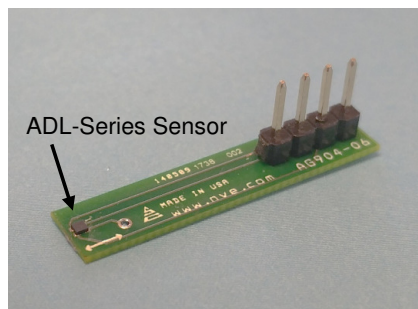

Figure 2. Typical operation; the circuit board arrow shows direction of sensitivity.

Typical magnetic operate and release distances for an inexpensive 4 mm diameter by 6 mm thick ceramic disk magnet, are illustrated in the following table:

Part	Operate Point (typ.)	Operate Distance (typ.)	Release Distance (typ.)
ADLx25-14E	1 mT	11 mm	13 mm
ADLx21-14E	2 mT	10 mm	12 mm
ADLx24-14E	2.8 mT	9 mm	11 mm
ADLx22-14E	4 mT	6 mm	9 mm

Larger and stronger magnets allow farther operate and release distances. For more calculations, use our digital sensor switching versus distance Web application at: www.nve.com/spec/calculators.php.

Illustrative Application Circuits

Direct-Drive LED Indicator

Although ADLxxx-14E series sensors are not capable of directly driving legacy LEDs, high-efficiency LEDs such as the APT3216LSECK are visible with the 100 μ A drive current provided by the sensors without an external driver.

This circuit illustrates a sensor powered by a single lithium button cell with a surface-mount indicator LED:

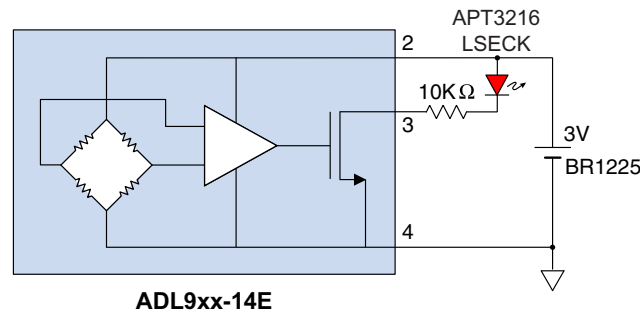

Figure 3. Typical ADLxxx-14E application.

Two-Wire Sensor Interface Using a Voltage Regulator

ADL-Series sensors are perfect for two-wire applications, because their low supply voltage and low quiescent current provide plenty of design margin. Two-wire interfaces need to operate over a wide power supply range. With the sensor off, the circuit must draw a minimal residual current, typically less than 1.5 milliamps. With the sensor on, the circuit must provide enough current to drive a significant load such as a motor or solenoid:

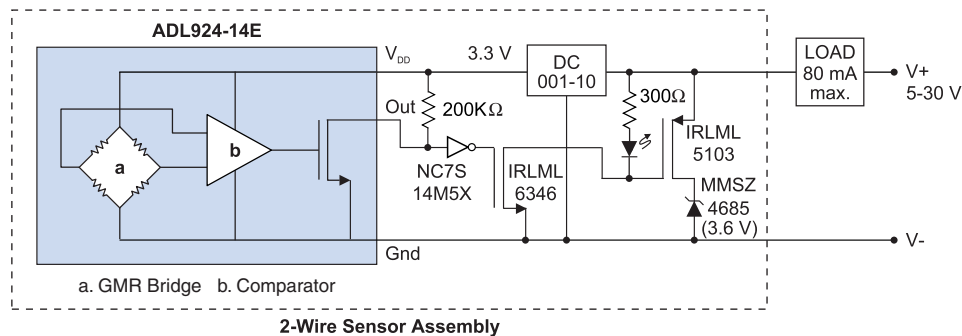

Figure 4. Typical two-wire circuit.

In this circuit, when a magnetic field is applied to the sensor, the MOSFETs turn on, turning on the LED and powering the load. This circuit uses an NVE DC001-10E regulator, which provides better regulation and operating latitude over the input voltage range than a Zener diode.

With no magnetic field and the sensor off, the residual current of the circuit is dominated by the DC001 regulator's quiescent current, which is less than one milliamp and relatively constant over input voltage. The Zener diode provides enough voltage to power the circuitry when the load is powered.

External Duty Cycling

ADL-Series continuous-duty sensors can be eternally duty-cycled. Unlike other types of sensors, the switching hysteresis is provided by the magnet sensor element, not a comparator, so the proper hysteresis state is retained when the part is duty-cycled:

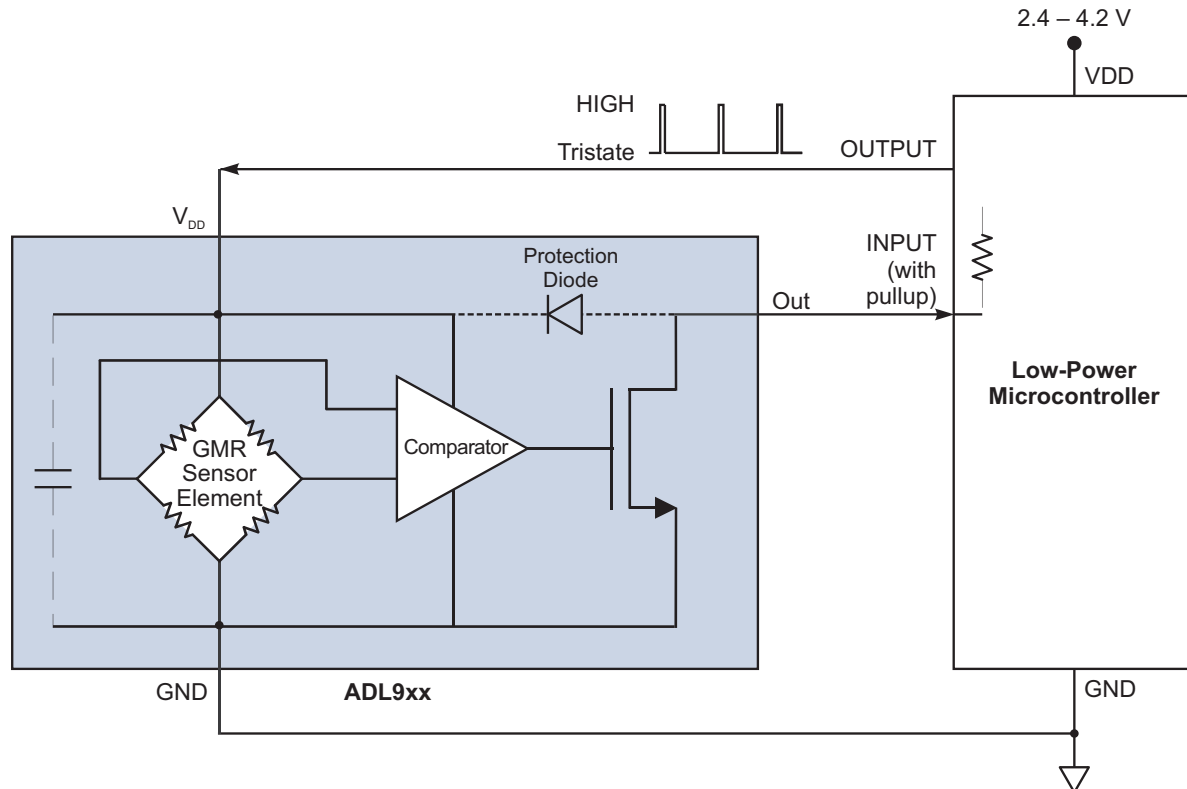

Figure 5. External duty cycling using a microcontroller.

Note that there is a protection diode from the output to V_{DD} , so that if V_{DD} is grounded the sensor output will be low (approximately 0.6 volts), and the pullup resistor will draw current. Therefore the most efficient way to duty cycle the sensor is to have an output driving V_{DD} to activate the part, and tri-state (rather than grounding) to deactivate the part.

Typical Performance Graphs

Average current increases with supply voltage but remains extremely low. The magnetic operate and release points are stable over temperature and supply voltage. Update frequency increases slightly with supply voltage.

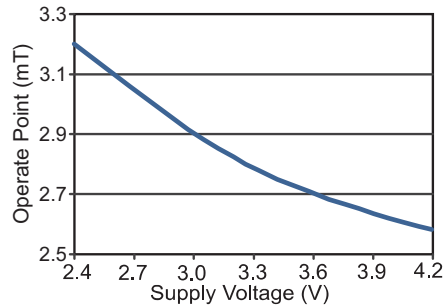

Figure 6. Typical magnetic operate versus supply voltage (ADLx24; 25 °C).

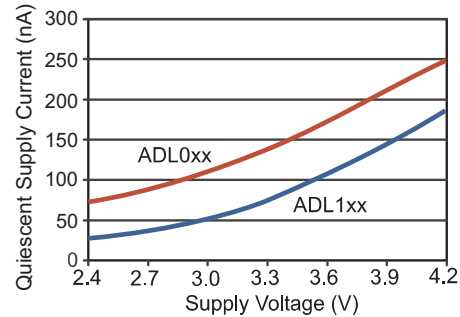

Figure 7. Typical Supply current versus supply voltage (ADL0xx and ADL1xx; 25 °C).

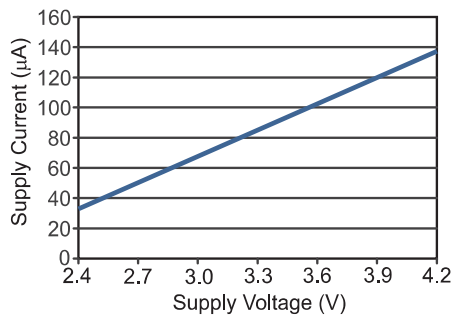

Figure 8. Typical Supply current versus supply voltage (ADL9xx; 25 °C).



ADLxxx Nanopower Digital Switches

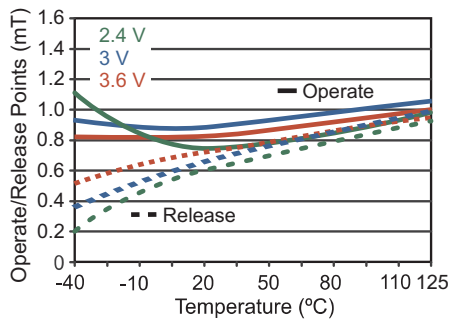

Figure 9. Typical magnetic operate point versus temperature (ADLx25).

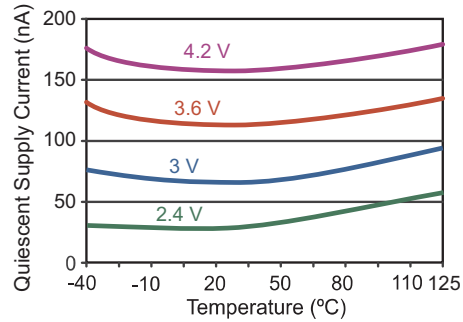

Figure 10. Typical supply current versus temperature (ADL1xx).

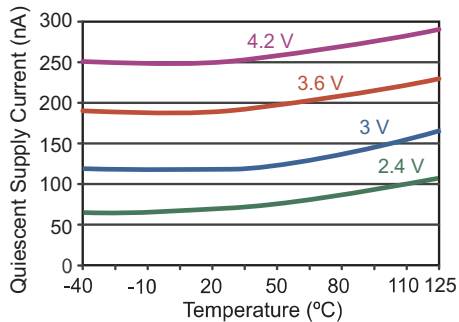

Figure 11. Typical supply current versus temperature (ADL0xx).

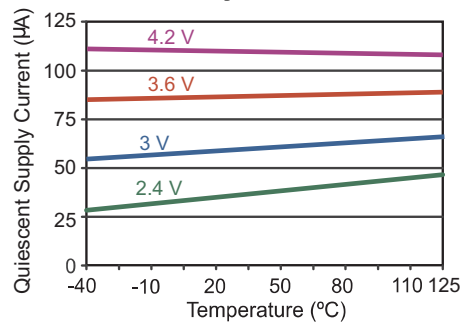

Figure 12. Typical supply current versus temperature (ADL9xx).



ADLxxx Nanopower Digital Switches

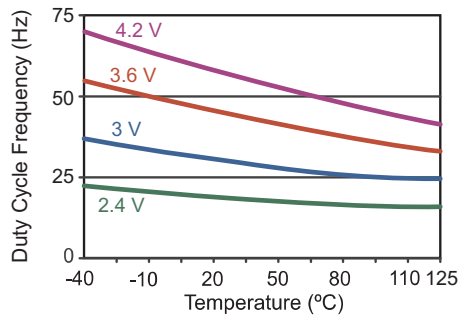

Figure 13. Typical update frequency versus temperature (ADL1xx).

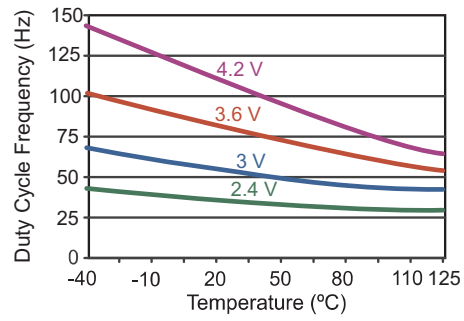

Figure 14. Typical update frequency versus temperature (ADL0xx).

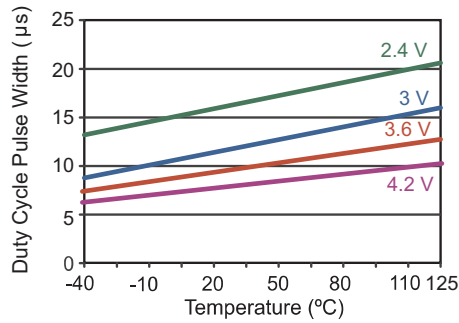
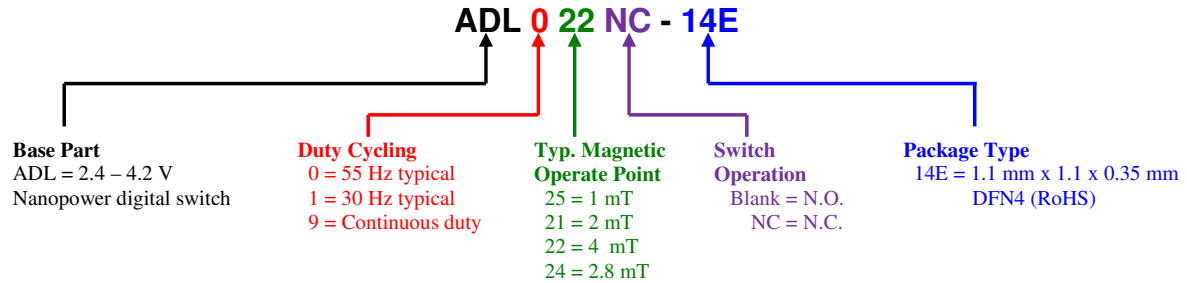

Figure 15. Typical update frequency versus temperature (ADL0xx and ADL1xx).

Part Numbering

The following example shows the ADL-Series part-numbering system:



Available Parts

Available Part	Duty Cycled?	Update Freq. (typ.)	Operate Point (typ.)	Switch Operation	Package	Package Marking
ADL021-14E	Y	55 Hz	2 mT	Normally Open	DFN4	V
ADL024-14E	Y	55 Hz	2.8 mT		DFN4	C
ADL025-14E	Y	55 Hz	1 mT		DFN4	J
ADL121-14E	Y	30 Hz	2 mT		DFN4	B
ADL124-14E	Y	30 Hz	2.8 mT		DFN4	D
ADL125-14E	Y	30 Hz	1 mT		DFN4	F
ADL921-14E	N	Continuous	2 mT		DFN4	M
ADL922-14E	N	Continuous	4 mT		DFN4	W
ADL922NC-14E	N	Continuous	4 mT	Normally Closed	DFN4	Q
ADL924-14E	N	Continuous	2.8 mT	Normally Open	DFN4	N
ADL925-14E	N	Continuous	1 mT		DFN4	P

Evaluation Kits

NVE offers two ADL-Series Demonstration Boards, one with a battery and one without. These inexpensive evaluation kits include demo boards with the ultraminiature, ultralow-power ADL021 magnetic switch included. An LED shows the sensor output. A miniature bar magnet is included so you can see for yourself how these remarkable sensors work. These miniature evaluation boards are just 40 x 6 mm (1.57 by 0.25 inches). Images are actual size:



AG040C: ADL021 Externally-Powered Evaluation Board

This board has a digital output, and can be powered from a 3.3-volt nominal supply. An LED shows the output.



AG040B: ADL021 Battery-Powered Demonstration Board

This board is powered by a three-volt lithium coin cell (included), and the sensor quiescent power consumption is so low that the battery will last indefinitely.

Bare Circuit Boards

NVE offers two bare circuit boards designed for easy connections to ULLGA DFN4 sensors. Note that since these boards use very small sensors, they require reflow or hot-air soldering techniques. Images are actual size:



AG904-06: DFN4 General-Purpose PCB

A 30 x 6 mm (1.2 x 0.25 inch) PCB for demonstrating 1.1 x 1.1 mm DFN4 sensors (-14E part number suffix).

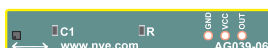

AG039-06: DFN4 Digital Sensor Demonstration Bare Board

A 40 x 6 mm (1.57 x 0.25 inch) PCB for demonstrating ADL-Series sensors (sensors sold separately). In addition to space for the sensor, the boards have locations for 0402-size pull-up resistors and bypass capacitors.



ADLxxx Nanopower Digital Switches

1.1 mm x 1.1 mm ULLGA DFN4 Package (-14E suffix)

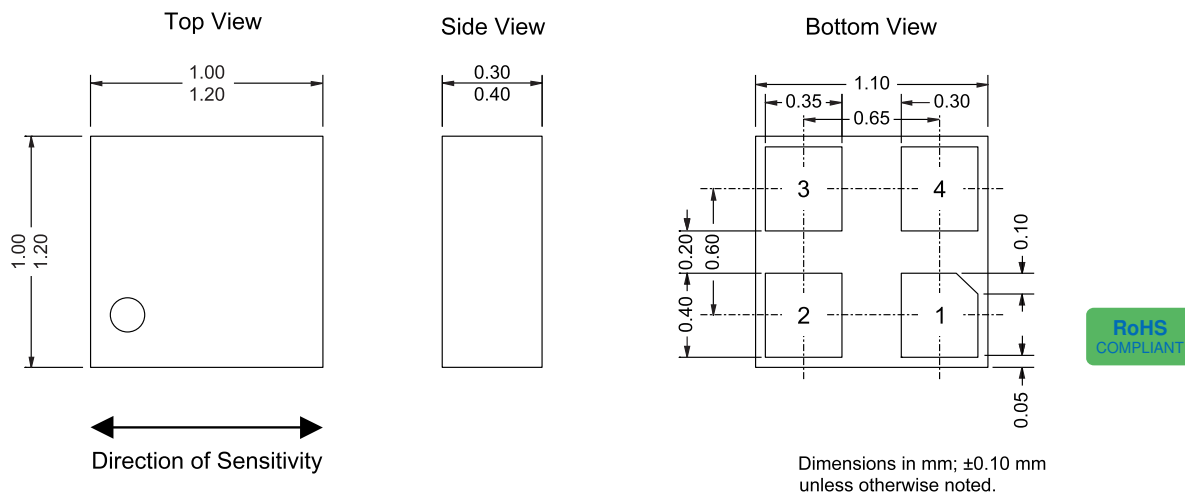

Pin 1	No Connect
Pin 2	V _{DD}
Pin 3	Out
Pin 4	Ground



Soldering profile per JEDEC J-STD-020C, MSL 1.

These products have been tested for electrostatic sensitivity to the limits stated in the specifications. However, NVE recommends that all integrated circuits be handled with appropriate care to avoid damage. Damage caused by inappropriate handling or storage could range from performance degradation to complete failure.

Revision History

<p>SB-00-017 March 2020</p>	<p>Change</p> <ul style="list-style-type: none"> • Added ADLx25 (1 mT typ. magnetic operate point), ADL922 (4 mT typ.), and ADL922NC (4 mT typ.; normally closed). • Added multiple supply voltages to magnetic operate point versus temperature graph. • Added graphs of supply current, duty cycle frequency, and pulse width vs. temperature. • Added external duty-cycling application circuit (p. 5). • Changed most magnetic units from Oe to mT.
<p>SB-00-017 July 2019</p>	<p>Change</p> <ul style="list-style-type: none"> • Added Iq supply specs for 4.2 V operation (p. 2). • Updated typical performance vs. supply at 4.2 V (p. 5; Figs. 4, 6-8).
<p>SB-00-017 September 2018</p>	<p>Change</p> <ul style="list-style-type: none"> • Tighter ADL0xx and ADL1xx quiescent supply current specifications (p. 2). • Updated graph of typical supply current vs. supply (p. 5; Fig. 5). • Added quiescent supply current specifications at 3-volt supply (p. 2). • More detailed output leakage current specification (p. 2).
<p>SB-00-017 November 2017</p>	<p>Change</p> <ul style="list-style-type: none"> • Added “Typical Operation” section and image (p. 3). • Added Evaluation Kits and bare boards (p. 7).
<p>SB-00-017 October 2017</p>	<p>Change</p> <ul style="list-style-type: none"> • Revised package outline dimensions.
<p>SB-00-017 May 2017</p>	<p>Changes</p> <ul style="list-style-type: none"> • Added application circuit. • Revised quiescent current specifications. • Added selector guide. • Obsoleted ADLx22 versions/ • Cosmetic changes.
<p>SB-00-017 December 2008</p>	<p>Change</p> <ul style="list-style-type: none"> • Initial Release.

Datasheet Limitations

The information and data provided in datasheets shall define the specification of the product as agreed between NVE and its customer, unless NVE and customer have explicitly agreed otherwise in writing. All specifications are based on NVE test protocols. In no event however, shall an agreement be valid in which the NVE product is deemed to offer functions and qualities beyond those described in the datasheet.

Limited Warranty and Liability

Information in this document is believed to be accurate and reliable. However, NVE does not give any representations or warranties, expressed or implied, as to the accuracy or completeness of such information and shall have no liability for the consequences of use of such information.

In no event shall NVE be liable for any indirect, incidental, punitive, special or consequential damages (including, without limitation, lost profits, lost savings, business interruption, costs related to the removal or replacement of any products or rework charges) whether or not such damages are based on tort (including negligence), warranty, breach of contract or any other legal theory.

Right to Make Changes

NVE reserves the right to make changes to information published in this document including, without limitation, specifications and product descriptions at any time and without notice. This document supersedes and replaces all information supplied prior to its publication.

Use in Life-Critical or Safety-Critical Applications

Unless NVE and a customer explicitly agree otherwise in writing, NVE products are not designed, authorized or warranted to be suitable for use in life support, life-critical or safety-critical devices or equipment. NVE accepts no liability for inclusion or use of NVE products in such applications and such inclusion or use is at the customer's own risk. Should the customer use NVE products for such application whether authorized by NVE or not, the customer shall indemnify and hold NVE harmless against all claims and damages.

Applications

Applications described in this datasheet are illustrative only. NVE makes no representation or warranty that such applications will be suitable for the specified use without further testing or modification.

Customers are responsible for the design and operation of their applications and products using NVE products, and NVE accepts no liability for any assistance with applications or customer product design. It is customer's sole responsibility to determine whether the NVE product is suitable and fit for the customer's applications and products planned, as well as for the planned application and use of customer's third party customers. Customers should provide appropriate design and operating safeguards to minimize the risks associated with their applications and products.

NVE does not accept any liability related to any default, damage, costs or problem which is based on any weakness or default in the customer's applications or products, or the application or use by customer's third party customers. The customer is responsible for all necessary testing for the customer's applications and products using NVE products in order to avoid a default of the applications and the products or of the application or use by customer's third party customers. NVE accepts no liability in this respect.

Limiting Values

Stress above one or more limiting values (as defined in the Absolute Maximum Ratings System of IEC 60134) will cause permanent damage to the device. Limiting values are stress ratings only and operation of the device at these or any other conditions above those given in the recommended operating conditions of the datasheet is not warranted. Constant or repeated exposure to limiting values will permanently and irreversibly affect the quality and reliability of the device.

Terms and Conditions of Sale

In case an individual agreement is concluded only the terms and conditions of the respective agreement shall apply. NVE hereby expressly objects to applying the customer's general terms and conditions with regard to the purchase of NVE products by customer.

No Offer to Sell or License

Nothing in this document may be interpreted or construed as an offer to sell products that is open for acceptance or the grant, conveyance or implication of any license under any copyrights, patents or other industrial or intellectual property rights.

Export Control

This document as well as the items described herein may be subject to export control regulations. Export might require a prior authorization from national authorities.

Automotive Qualified Products

Unless the datasheet expressly states that a specific NVE product is automotive qualified, the product is not suitable for automotive use. It is neither qualified nor tested in accordance with automotive testing or application requirements. NVE accepts no liability for inclusion or use of non-automotive qualified products in automotive equipment or applications.

In the event that customer uses the product for design-in and use in automotive applications to automotive specifications and standards, customer (a) shall use the product without NVE's warranty of the product for such automotive applications, use and specifications, and (b) whenever customer uses the product for automotive applications beyond NVE's specifications such use shall be solely at customer's own risk, and (c) customer fully indemnifies NVE for any liability, damages or failed product claims resulting from customer design and use of the product for automotive applications beyond NVE's standard warranty and NVE's product specifications.



ADLxxx Nanopower Digital Switches

An ISO 9001 Certified Company

NVE Corporation
11409 Valley View Road
Eden Prairie, MN 55344-3617 USA
Telephone: (952) 829-9217

www.nve.com
e-mail: sensor-info@nve.com

©NVE Corporation
All rights are reserved. Reproduction in whole or in part is prohibited without the prior written consent of the copyright owner.

SB-00-017

rev. March 2020

14

NVE Corporation 11409 Valley View Road, Eden Prairie, MN 55344-3617 Phone: (952) 829-9217 www.nve.com ©NVE Corporation

We are here for you. Addresses and Contacts.

Headquarter Switzerland:

Angst+Pfister Sensors and Power AG
Thurgauerstrasse 66
CH-8050 Zurich
Phone +41 44 877 35 00
sensorsandpower@angst-pfister.com

Office Germany:

Angst+Pfister Sensors and Power Deutschland GmbH
Edisonstraße 16
D-85716 Unterschleißheim
Phone +49 89 374 288 87 00
sensorsandpower.de@angst-pfister.com

Scan here and get an overview of personal contacts!



sensorsandpower.angst-pfister.com
