

Φ38 FAMILY

Incremental Encoders

Connector (Hirose Electric) 38S/38H

Output type	Parts Number
Open Collector	DF3-6S-2C
Complementary	DF3-6S-2C
Line Driver	DF3-9S-2C



Electrical spec

Output Type	A, B, Z (index signal)	
Resolution	100, 200, 250, 300, 360, 500, 512, 600, 1000, 1024, 2000, 2048, 2500, 3600, 4000, 4096	200, 250, 300, 360, 500, 512, 1000, 1024, 2000, 2048, 2500, 3600, 4000, 4096
Supply voltage	Line driver	DC4.5~13.2V
	Open collector Complementary	DC4.5~30V
Current consumption	30mA, Complementary : 60mA (Max)	
Output current	Line driver	20mA (Max)
	Open collector	40mA (Max)
	Complementary	600mA (Max)
Operating frequency	240kHz (Max)	

Mechanical spec

Shaft diameter	Φ6	Φ6, Φ8	Φ5, Φ6
Sealing	IP 50		
Starting torque	9.8 × 10 ⁻⁴ N·m or Less		
Allowable load to the shaft	Thrust : 19.6N / Radial : 29.4N	Thrust : 9.8N / Radial : 29.4N	—
Moment of inertia	8 × 10 ⁻⁷ kg·m ² (Max)		9.3 × 10 ⁻⁷ kg·m ² (Max)
Max Rotating speed	6000r/min. (Max)		10000r/min. (Max)

38S Series

■ Type **38S** - [] - [] - **6** - **50** - **B00 E**

Resolution: Refer to above
Cable length 50 : 50cm
Shaft diameter 6 : Φ6
2MD : A, B, Z Line driver
2MC : A, B, Z Open collector
2MT : A, B, Z Complementary

Dimensions (mm)

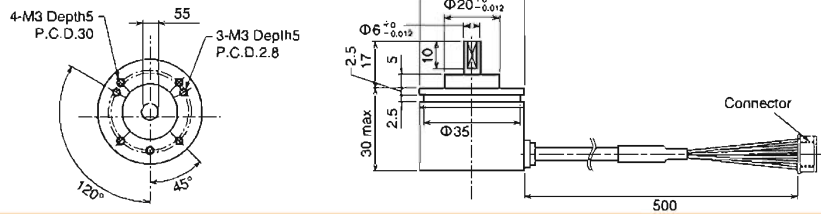

38H Series

■ Type **38H** - [] - [] - [] - **50** - **B00 E**

Resolution: Refer to above
Cable length 50 : 50cm
Inner diameter 6 : Φ6
8 : Φ8
2MD : A, B, Z Line driver
2MC : A, B, Z Open collector
2MT : A, B, Z Complementary

Dimensions (mm)

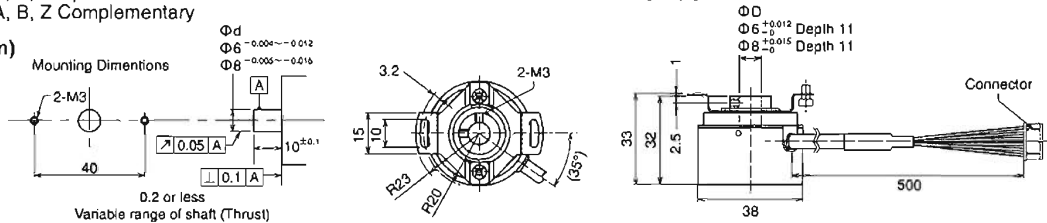

38M Series

■ Type **38M** - [] - [] - **A** [] - **00 E**

Resolution: Refer to above
Motor Inner diameter 50 : Φ5
60 : Φ6
2MD : A, B, Z Line driver
2MC : A, B, Z Open collector
2MT : A, B, Z Complementary

Connector

JST SM10B-GHS-GB-TB

Dimensions (mm)

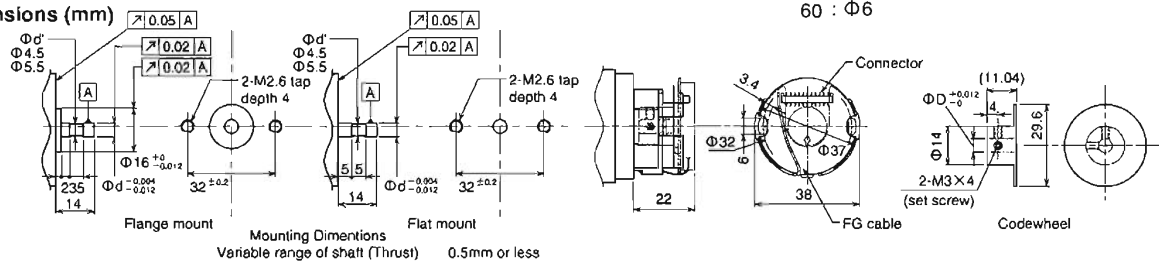

Φ18 / Φ38 Other Spec

■ Φ18 Cable assign

Open collector

Pin No.	Color	Connection
1	Brown	Vcc
2	Red	0V
3	Orange	Sig A
4	Yellow	Sig B
5	Green	Sig Z

Line driver

Pin No.	Color	Connection
1	Brown	Vcc
2	Red	0V
3	Orange	Sig A
4	Yellow	Sig A
5	Green	Sig B
6	Blue	Sig B
7	Purple	Sig Z
8	Gray	Sig Z
9	Black	—

■ 38S / 38H Cable assign

Open collector / Complementary

Pin No.	Color	Connection
1	Red	Vcc
2	Black	0V
3	Blue	Sig A
4	White	Sig B
5	Yellow	Sig Z
6	Black	Shield

Line driver

Pin No.	Color	Connection
1	Red	Vcc
2	Black	0V
3	Green	Sig A
4	Blue	Sig A
5	White	Sig B
6	Gray	Sig B
7	Yellow	Sig Z
8	Orange	Sig Z
9	Black	Shield

■ Circuit of Output Signal

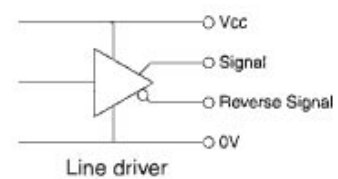
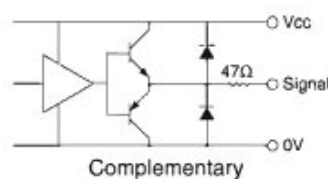
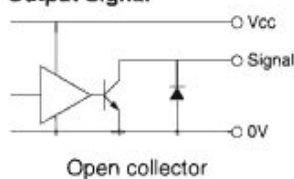

■ Output style

Rotation direction

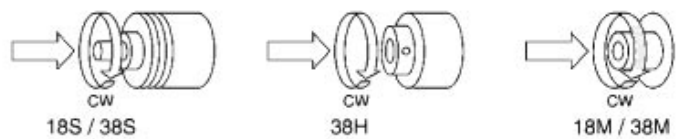

Open collector output / Complementary output : Signal A, B, Z

Line driver output : Signal A, B, Z, /A, /B, /Z

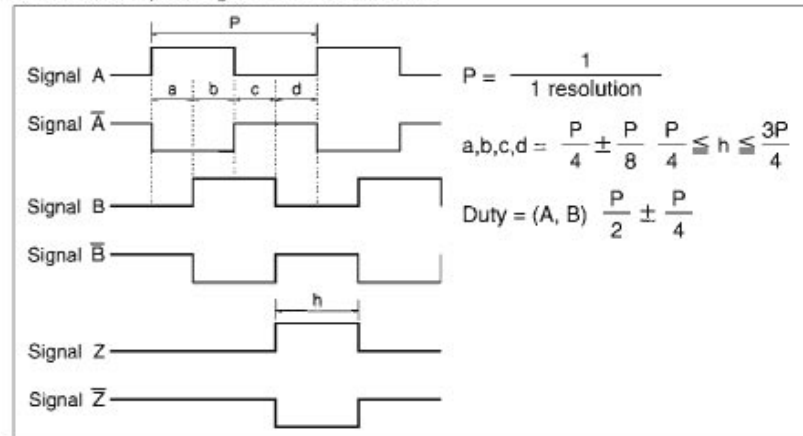

■ 38M Connector assign

Open collector / Complementary

Pin No.	Connection
1	Vcc
2	0V
3	Sig A
4	—
5	Sig B
6	—
7	Sig Z
8	—
9	—
10	Shield
11	—

Line driver

Pin No.	Connection
1	Vcc
2	0V
3	Sig A
4	Sig A
5	Sig B
6	Sig B
7	Sig Z
8	Sig Z
9	—
10	Shield
10	—

■ Environmental spec

Operating temperature	-10°C ~ +85°C
Humidity	RH 85% Max*
Vibration	10~55Hz/1.5mm X, Y, Z direction each 2h
Shock	490m/s ² , 11ms X, Y, Z direction each for 3 times

*No Condensation

This content on this sheet is subject to change without advance notice due to the technical development and progress etc.
When using this product, please refer to the latest specifications.

PS11004

Headquarter Switzerland:
Angst+Pfister Sensors and Power AG

Thurgauerstrasse 66
CH-8050 Zurich
Phone +41 44 877 35 00
sensorsandpower@angst-pfister.com

Office Germany:
Angst+Pfister Sensors and Power
Deutschland GmbH
Edisonstraße 16
D-85716 Unterschleißheim
Phone +49 89 374 288 87 0
sensorsandpower.de@angst-pfister.com



We are here for you. Addresses and Contacts.

Sales Germany & Austria

Geometrical sensors
Other products

Kurt Stritzelberger
Phone +49 89 374 288 87 22
kurt.stritzelberger@angst-pfister.com

Pressure sensors
Other products

Gerhard Vetter
Phone +49 89 374 288 87 26
gerhard.vetter@angst-pfister.com

Gas sensors and modules

Peter Felder
Phone +41 44 877 35 05
peter.felder@angst-pfister.com

Sales Switzerland & Liechtenstein

Postcode 3000 – 9999

Basil Frei
Phone +41 44 877 35 18
basil.frei@angst-pfister.com

Postcode 1000 – 2999

Christian Mohrenstecher
Phone +41 76 444 57 93
christian.mohrenstecher@angst-pfister.com

Sales International Key Accounts

Peter Felder
Phone +41 44 877 35 05
peter.felder@angst-pfister.com

Sales Other Countries / Product Management

Pressure Sensors
Load Cells

Philipp Kistler
Phone +41 44 877 35 03
philipp.kistler@angst-pfister.com

Gas sensors
Gas sensor modules

Dr. Thomas Clausen
Phone +49 89 374 288 87 24
thomas.clausen@angst-pfister.com

Flow / Level / Medical products

Dr. Adriano Pittarelli
Phone +49 89 374 288 87 67
adriano.pittarelli@angst-pfister.com

Power supplies

Sebastiano Leggio
Phone +41 44 877 35 06
sebastiano.leggio@angst-pfister.com

Linear position sensors
Angle sensors

Eric Letsch
Phone +41 44 877 35 14
eric.letsch@angst-pfister.com

Accelerometers
Sensor elements

Christoph Kleye
Phone +49 89 374 288 87 61
christoph.kleye@angst-pfister.com

Drive technology
CH Postcode 5000 – 9999 / DE

Roman Homa
Phone +41 76 444 00 86
roman.homa@angst-pfister.com

Drive technology
CH Postcode 1000 – 4999 / AT / IT / FR

Christian Mohrenstecher
Phone +41 76 444 57 93
christian.mohrenstecher@angst-pfister.com

Harald Thomas
Phone +49 89 374 288 87 23
harald.thomas@angst-pfister.com